

SARATOGA SPA®
OWNER'S MANUAL



LUXURY EDITION
INTERNATIONAL 50HZ

Model: _____

Serial Number: _____

Date Installed: _____

Dealer: _____

Address: _____

Telephone: _____

Note: The serial number/identification label is located within the equipment compartment and skimmer housing.

LUXURY SERIES

MODEL	AVG. FILL	AVG. FILL WEIGHT	AVG. DRY WEIGHT
Polo	150 gal. / 568 L	1638 lbs. / 743 kg.	385 lbs. / 175 kg.
Adelphi	240 gal. / 909 L	2504 lbs. / 1136 kg.	500 lbs. / 227 kg.
Putnam	340 gal. / 1287 L	3457 lbs. / 1568 kg.	620 lbs. / 281 kg.
Canfield	375 gal. / 1420 L	3880 lbs. / 1760 kg.	750 lbs. / 340 kg.
Regent*	425 gal. / 1609 L	4297 lbs. / 1949 kg.	750 lbs. / 340 kg.
Lincoln	525 gal. / 1988 L	5302 lbs. / 2405 kg.	920 lbs. / 417 kg.
Empire	525 gal. / 1988 L	5302 lbs. / 2405 kg.	920 lbs. / 417 kg.
Broadway	795 gal. / 3010 L	7835 lbs. / 3554 kg.	1200 lbs. / 544 kg.



Thank you for your recent Saratoga Spa® Purchase.

This owners manual has been designed to acquaint you with your Saratoga Spa's® operation and general maintenance.

Keep this manual available for future reference.

If you have any questions regarding your Saratoga Spa®, contact your local dealer.

Thank you.

* The Regent is a Special Edition Model. Not all Luxury features apply.

TABLE OF CONTENTS

SARATOGA SPA® SAFETY INSTRUCTIONS

Avoiding Risk to Children	2
Avoiding Risk of Electrical Shock	2
Avoiding Risk of Injury	3
Unclean Water	3
Avoiding Risk of Hyperthermia	4
Avoiding Risk of Skin Burns	4
Important Do's and Don'ts	5

LUXURY LINE SPA MODEL SPECIFICATIONS

Specifications	6
----------------	---

LUXURY LINE FEATURES AND OPERATIONS

Polo	7
Adelphi	8
Putnam	9
Canfield	10
Regent Special Edition	11
Lincoln	12
Empire	13
Broadway	14

INSTALLATION INSTRUCTIONS

Location Preparation	15
Outdoor Installation	15
Indoor Installation	15

ELECTRICAL REQUIREMENTS AND PRECAUTIONS

230 V Permanently Connected Models	16
Electrical Installation Instructions	16-17
Electrical Spa Wiring Connection Instructions	17-19

INITIAL OPERATING INSTRUCTIONS

Start-up and Refill Procedures	20
Start-up Procedures	21-22
Saratoga Spa® Jet Identifications	23-24
Saratoga Spa® Jet Selectors	25

JET SYSTEM MENUS

Jet Therapy Zones	26
Polo	27
Adelphi	28
Putnam	29
Canfield	30-31
Regent	32-33
Lincoln	34-35
Empire	36-37
Broadway	38-39

EQUIPMENT MAINTENANCE

Jet Valve Maintenance	40
Roto Stream™ Valve Maintenance	40-41
LED Light Bulb Replacement	41

CONTROL PANEL FUNCTIONS

Main Control Panel	42
Main Control Panel Buttons and Digital Display	42
Temperature Control	42
Operating the Hydro Pumps	42-43
Jet Buttons	42-43
Light Control/Lighting System	44
Optional Luxury Sound Systems	44
Heating Modes	44
Filter Cycle Modes	44-45
Freeze Protection	45
Summer Set Mode	45
Automated Purge Cycle	45
Satellite Panel	45

SPA CARE AND WATER MAINTENANCE

General Information	45-46
Filter Cartridge Removal and Cleaning	46-47
Care of Pillows	47
Care of Exterior	47-48
Care of Spa Cover	48
Winterizing Your Spa	48-49
Water Quality Maintenance	50-52
Ozone Generators	52

TROUBLESHOOTING

Operations Trouble Shooting Guide	53-54
Diagnostic Display Messages	55

SERVICE AND WARRANTY INFORMATION

Delivery and Moving Instructions	56
Service and Warranty Information	57
Spa Care and Maintenance Record	58-61

SARATOGA SPA® SAFETY INSTRUCTIONS

Read And Follow All Instructions

AVOIDING THE RISK TO CHILDREN

RISK OF CHILD DROWNING

Extreme caution must be exercised to prevent unauthorized access by children. To avoid accidents, ensure that children cannot use a spa unless they are supervised at all times.



- To reduce the risk of injury, do not permit children to use this spa unless they are closely supervised at all times.
- To reduce the risk of injury, lower water temperatures and control the time of hot water exposure for young children. Children are especially sensitive to hot water.



RISK OF ELECTROCUTION

- Connect only to a grounded source.
- Do not bury the power cord. A buried power cord may result in death, or serious personal injury due to electrocution if direct burial-type cable is not used, or if improper digging occurs.
- A ground terminal (pressure wire connector) is provided on the control box inside the unit to permit connection of a minimum No. 8 AWG (8.4mm²) solid copper bonding conductor between this point and any metal equipment, metal water pipe, metal enclosures of electrical equipment, or conduit within five feet (1.5 m) of the unit as needed to comply with local requirements.
- To reduce the risk of electrocution, replace all damaged cords immediately. Failure to do so may result in death or serious personal injury due to electrocution.
- Do not connect any auxiliary components (for example, additional cable speakers, headphones or other audio components) to the audio system unless approved by Saratoga Spa® Company.
- Do not self-service audio components by opening or removing the cover as this may expose you to dangerous voltage or other risk of injury. Only qualified service personnel should service your spa and its components.
- Do not attach an external antenna to a spa audio system unless it is installed by a licensed electrician in accordance with Article 810 of the National Electric Code, ANSI/NFPA 70.



AVOIDING RISK OF ELECTRICAL SHOCK

- Do not permit any electrical appliance, such as a light, telephone, radio or television within 5 feet (1.5m) of a spa. These units DO NOT have an internal ground fault circuit interrupter. The installation of a ground fault circuit interrupter MUST be done by a qualified Electrician and must meet all local and national codes. Failure to maintain a safe distance may result in death, or serious personal injury due to electrocution, if the appliance should fall into the spa.

- Install at least 5 feet (1.5 m) from all metal surfaces. A spa may be installed within 5 feet of a metal surface if each metal surface is permanently connected by a minimum No. 8 AWG (8.4mm²) solid copper conductor attached to the wire ground connector on the terminal box that is provided for this purpose if in accordance with National Electrical Code ANSI/NMFA70-1993.
- Install your spa in such a way that drainage is away from the electrical compartment and from all electrical components.



AVOIDING RISK OF INJURY

- To reduce the risk of injury to persons, DO NOT remove suction fittings located at the bottom footwell of the spa.
- The suction fittings in the spa are sized to match the specific water flow created by the pump. Never replace a suction fitting with one rated less than the flow rate marked on the original suction fitting. Never operate the spa if the suction fittings are broken or missing.
- There is a danger of slipping and falling. Remember that wet surfaces can be very slippery. Take care when entering or exiting the spa.
- People with infectious diseases should not use the spa.
- Keep any loose articles of clothing or hanging jewelry away from rotating jets or other moving components.
- The use of drugs, alcohol, or medication before or during spa use may lead to unconsciousness with the possibility of drowning.
- Persons using medications should consult a physician before using a spa; some medication may cause a user to become drowsy, while other medication may affect heart rate, blood pressure, and circulation.
- Persons taking medications which induce drowsiness, such as tranquilizers, antihistamines or anticoagulants should not use the spa.
- Water temperature in excess of 104°F (38°C) may be injurious to your health.
- Pregnant women should consult a physician before using spa.
- Persons suffering from obesity, or with a medical history of heart disease, low or high blood pressure, circulatory system problems, or diabetes should consult a physician before using spa.
- Persons using or having Implanted Pacemakers or Defibrillators should consult their physician prior to using a spa, as there are risks of electrocution.

UNCLEAN WATER

- Keep the water clean and sanitized with correct chemical care.
- Maintain water chemistry in accordance with chemical manufacturer's instructions.

Important:

- Turn the Jet Pump on high speed after adding ANY spa water chemicals into the spa. It will operate for a 15 minute cycle before shutting off automatically.
- Clean the filter cartridges monthly to remove debris and mineral buildup which may affect the performance of the jets, limit the flow, or cause a high limit problem.



AVOIDING RISK OF HYPERTHERMIA

The causes, symptoms and effects of hyperthermia may be described as follows: Hyperthermia occurs when the internal temperature of the body reaches a level several degrees above the normal body temperature of 98.6°F (37°C). The symptoms of hyperthermia include an increase in the internal temperature of the body, dizziness, lethargy, drowsiness and fainting.

The effects of hyperthermia include:

1. Failure to perceive heat.
2. Failure to recognize the need to exit the spa or hot tub.
3. Unawareness of impending hazard.
4. Fetal damage in pregnant women.
5. Physical inability to exit the spa or hot tub.
6. Unconsciousness resulting in drowning.



The use of alcohol, drugs, or medication can greatly increase the risk of fatal hyperthermia in hot tubs and spas.



To Reduce The Risk of Injury:

- The water in the spa should never exceed 104°F (40°C). Water temperatures between 100°F (37.7°C) and 104°F (40°C) are considered safe for a healthy adult.
- Lower water temperatures are recommended for extended use (exceeding ten minutes) and for young children. Extended use can cause hyperthermia.
- Pregnant or possibly pregnant women should consult with their physician before entering a spa. Failure to do so may result in permanent injury to your baby.
- Do not use spa immediately following strenuous exercise.



AVOIDING RISK OF SKIN BURNS

- To reduce the risk of injury, before entering a spa the user should measure the water temperature with an accurate thermometer, since the tolerance of temperature-regulating devices may vary by as much as $\pm 5^\circ$.
- Test the water with your hand before entering the spa to be sure it's comfortable.

Important:

The following contains important spa information, and we strongly encourage you to read and apply them.

IMPORTANT DO'S & DON'TS**Do:**

- Make sure you always lock the child resistant spa cover locks after using the spa for your children's safety. Every Saratoga Spa® is equipped with a locking cover that meets the ASTM F1346-91 Standard for Safety Covers.
- Test the water temperature with your hand before allowing people to enter the spa to be sure that it's comfortable. Remember, children are especially sensitive to hot water.
- Remind children that wet surfaces can be very slippery. Make sure that children are careful when entering or exiting the spa.
- Use and lock the vinyl cover when the spa is not in use, whether it is empty or full.
- Follow the Spa Care and Maintenance recommendations stated in this manual.
- Use only approved accessories and recommended spa chemicals and cleaners.
- Keep the spa cover locked when the spa is not in use.
- Check the equipment compartment monthly for any signs of tampering to the spa equipment.
- Follow the maintenance instructions of the spa found in this owner's manual.
- Be sure your spa is connected to the power supply correctly - use a licensed electrical contractor.
- Test the Residual Current Device once a month.
- Place the spa on a level load bearing surface.

**Don't:**

- Allow children to climb onto the spa cover.
- Allow children to have unsupervised access to the spa.
- Leave the Saratoga Spa® exposed to the sun without water or the cover in place. Exposure to direct sunlight can cause solar distress of the shell material.
- Lift or drag the vinyl cover by using the cover lock straps; always lift or carry the cover by using the handles.
- Attempt to open the electrical control box. There are no user serviceable parts inside. Opening of the control box by the spa owner will void the warranty. If you have an operational problem, carefully go through the steps outlined in the Troubleshooting section. If you are not able to resolve the problem, contact your authorized Saratoga Spa® dealer. Many problems can easily be diagnosed over the telephone by an Authorized Service Technician.
- Block or sit on the filter compartment area.
- Allow excessive weight to be placed on the spa cover. Doing so could damage the spa cover and void any warranty.
- Use the spa with the equipment compartment door removed.
- Place electrical appliances within 5 feet (1.5m) of the spa.
- Block the equipment compartment vents. This could cause damage to the spa equipment and will void the warranty.

*** SAVE THESE INSTRUCTIONS ***

SPA SPECIFICATIONS

	Width	Length	Height	Average Fill	Dry Weight	Average Fill Weight	Seating Locations
Polo	57" 1.45 m	80" 2.03 m	29" 0.74 m	150 gal. 568 L	385 lbs. 175 L	1,638 lbs. 743 kg.	2
Adelphi	67" 1.70 m	80" 2.03 m	29" 0.74 m	240 gal. 909 L	500 lbs. 227 kg	2,504 lbs. 1,136 kg	2–3
Putnam	75" 1.91 m	84" 2.13 m	36" 0.91 m	340 gal. 1,287 L	620 lbs. 281 kg	3,457 lbs. 1,568 kg	4–5
Canfield	84" 2.13m	84" 2.13 m	38" 0.97 m	375 gal. 1,420 L	750 lbs. 340 kg	3,880 lbs. 1,760 kg	5–6
Regent	84" 2.13 m	90" 2.29 m	38" 0.97 m	425 gal. 1609 L	750 lbs. 340 kg	4,297 lbs. 1,949 kg	5–6
Lincoln	90" 2.29 m	94" 2.39 m	40" 1.02 m	525 gal. 1988 L	920 lbs. 417 kg	5,302 lbs. 2,405 kg	6–7
Empire	89" 2.26 m	93" 2.36 m	40" 1.02m	525 gal. 1988 L	920 lbs. 417 kg	5,302 lbs. 2,405 kg	6–7
Broadway	92" 2.34 m	108" 2.74 m	40" 1.02 m	795 gal. 3010 L	1200 lbs. 544 kg	7,835 lbs. 3,554 kg	9



Due to the risk of property damage and injury, the manufacturer of the Saratoga Spa® strongly suggests a structural engineer or licensed contractor be consulted before the spa is placed on an elevated deck.

Note: The “Average Full” weight of the spa includes only the spa and the water inside the spa.

Spa Features

- A. Versa-Flo™ Micro Valves
- B. Air Valves
- C. Power Massage® Jets
- D. Deluxe Jets
- E. Cluster Jets
- F. Standard Jets
- G. Vortex Jet™ Circulation
- H. Whisper Clean® Jet
- I. Footwell Spa Drain
- J. Relax Stream™ Waterfall
- K. Backlit Digital Control Panel
- L. Microban® Filtration
- M. Toploading Skimmer
- N. Pillows
- O. Mood Light

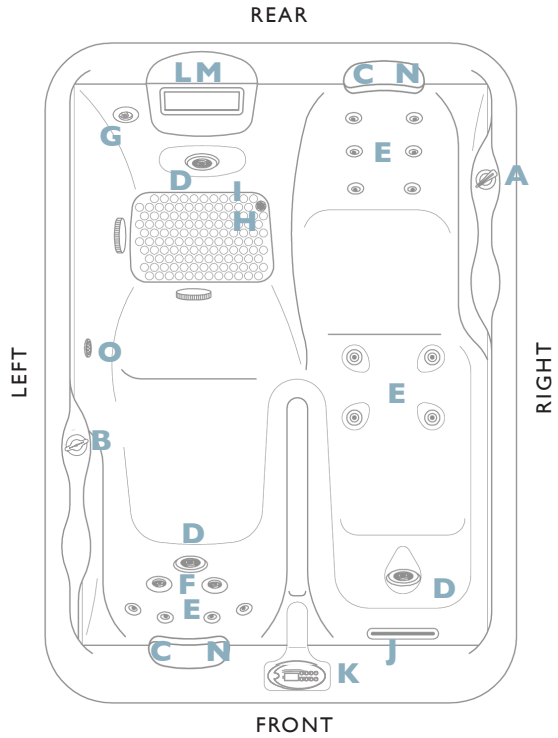

Operations Center

- | | |
|---|----------------------|
| 1. (1) Two Speed Hydro Pump | 6. Drain Valve |
| 2. 3 kW Heater | 7. Mood Light |
| 3. Purity Circulation™ Pump | 8. Bonding Terminal |
| 4. 230V Power Pack | 9. Shut-Off Valves |
| 5. Whisper Zone™ Ozonator- Located behind the 230V Power Pack | 10. Turbo Boost Pump |

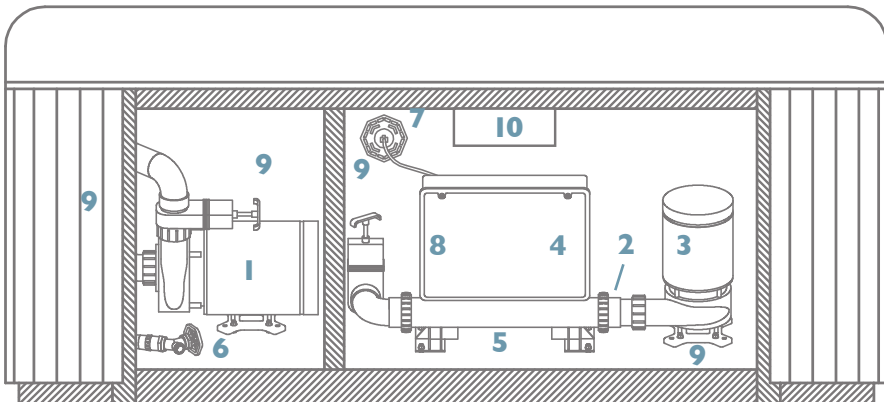

ADELPHI

Spa Features

- A. Versa-Flo™ Micro Valves
- B. Air Valves
- C. Power Massage® Jets
- D. Power Stream® Jets
- E. Cluster Jets
- F. Standard Jets
- G. Storm Jets
- H. Vortex Jet™ Circulation
- I. Whisper Clean® Jet
- J. Footwell Spa Drain
- K. Relax Stream™ Waterfall
- L. Backlit Digital Control Panel
- M. Microban® Filtration
- N. Toploading Skimmer
- O. Pillows
- P. Mood Light

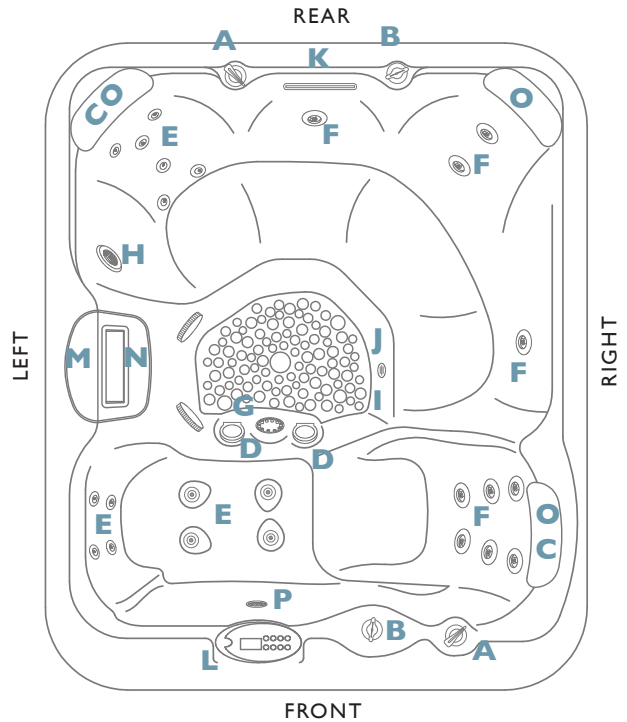

Operations Center

- | | |
|---|----------------------|
| 1. (1) Two Speed Hydro Pump | 6. Drain Valve |
| 2. 3 kW Heater | 7. Mood Light |
| 3. Purity Circulation™ Pump | 8. Bonding Terminal |
| 4. 230V Power Pack | 9. Shut-Off Valves |
| 5. Whisper Zone™ Ozonator- Located behind the 230V Power Pack | 10. Turbo Boost Pump |

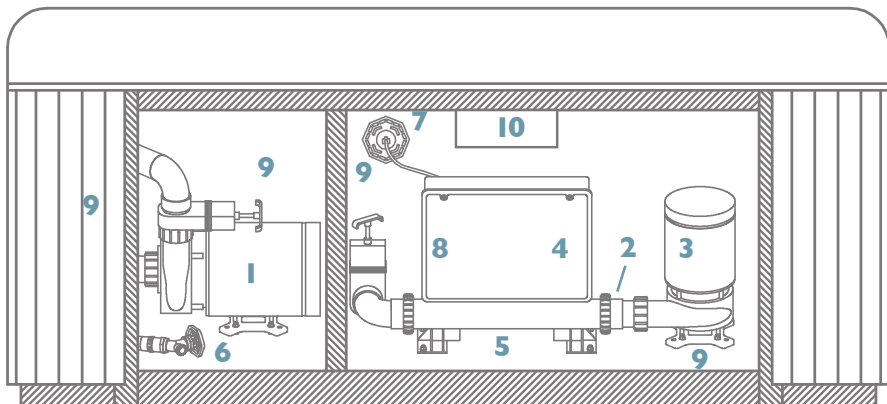

Spa Features

- A. Versa-Flo™ Micro Valves
- B. Air Valves
- C. Power Massage® Jets
- D. Power Stream® Jets
- E. Cluster Jets
- F. Standard Jets
- G. Deluxe Jets
- H. Storm Jets
- I. Vortex Jet™ Circulation
- J. Whisper Clean® Jet
- K. Footwell Spa Drain
- L. Relax Stream™ Waterfall
- M. Backlit Digital Control Panel
- N. Microban® Filtration
- O. Toploading Skimmer
- P. Pillows
- Q. Mood Light

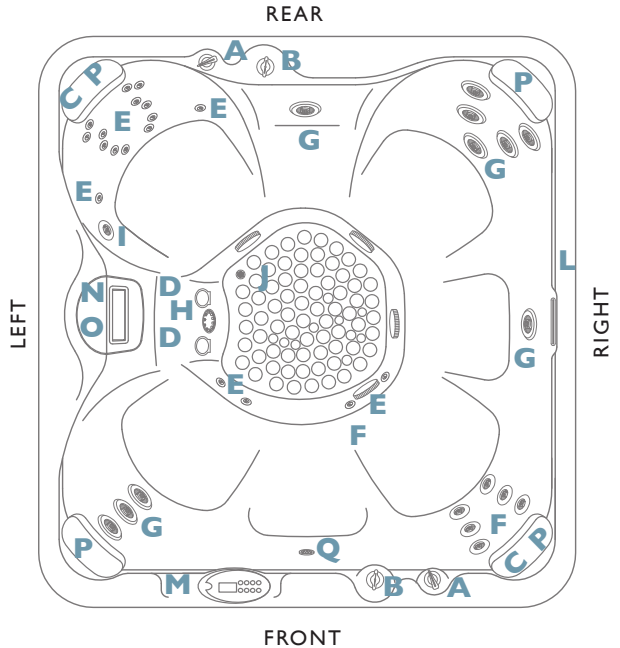

Operations Center

- 1. (1) Two Speed Hydro Pump
- 2. (1) Single Speed Hydro Pump
- 3. 3 kW Heater
- 4. Purity Circulation™ Pump
- 5. 230V Power Pack
- 6. Whisper Zone™ Ozonator- Located behind the Purity Circulation™ Pump
- 7. Drain Valve
- 8. Mood Light
- 9. Bonding Terminal
- 10. Shut- Off Valves
- 11. Turbo Boost Pump

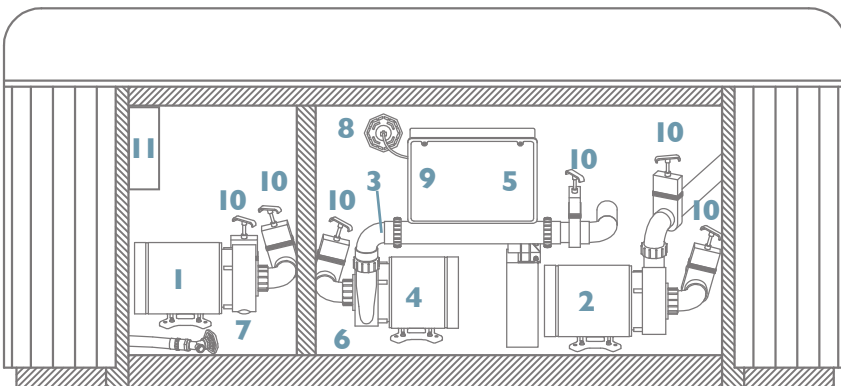

CANFIELD

Spa Features

- A. Versa-Flo™ Valves/
Versa-Flo™ Micro Valves
- B. Air Valves
- C. Mood Light
- D. Power Massage® Jets
- E. Power Stream® Jets
- F. Whisper Clean® Jet
- G. Cluster Jets
- H. Standard Jets
- I. Deluxe Jets
- J. Storm Jets
- K. Vortex Jet™ Circulation
- L. Footwell Spa Drain
- M. Relax Stream™ Waterfall
- N. Backlit Digital Control Panel
- O. Microban® Filtration
- P. Toploading Skimmer
- Q. Pillows
- R. Roto Stream™ Valves

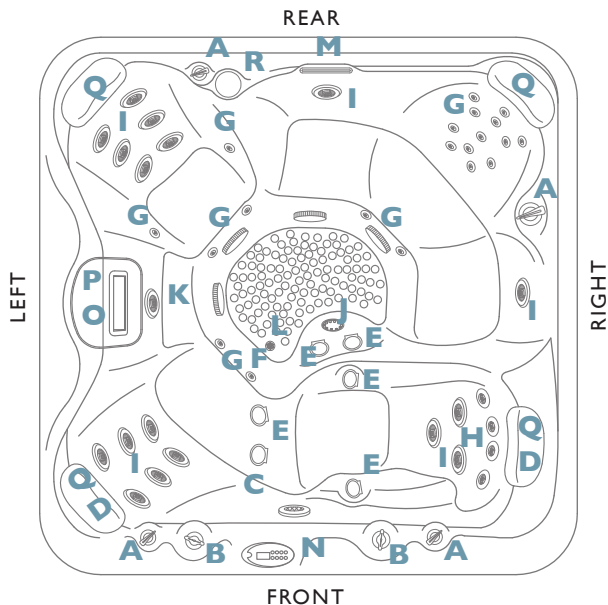

Operations Center

1. (1) Two Speed Hydro Pump
2. (1) Single Speed Hydro Pump
3. 3 kW Heater
4. Purity Circulation™ Pump
5. 230V Power Pack
6. Whisper Zone™ Ozonator- Located behind the Purity Circulation™ Pump
7. Drain Valve
8. Mood Light
9. Bonding Terminal
10. Shut- Off Valves
11. Turbo Boost Pump

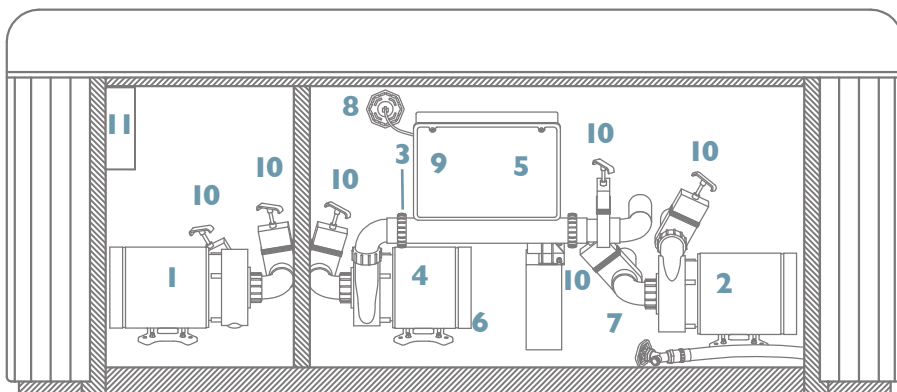

REGENT SPECIAL EDITION

Spa Features

- A. Versa-Flo™ Valves/
Versa-Flo™ Micro Valves
- B. Air Valves
- C. Manual Roto Stream™ Valve
- D. Power Massage® Jets
- E. Power Stream® Jets
- F. Cluster Jets
- G. Standard Jets
- H. Deluxe Jets
- I. Storm Jets
- J. Master Massage
- K. Vortex Jet™ Circulation
- L. Whisper Clean® Jet
- M. Footwell Spa Drain
- N. Relax Stream™ Waterfall
- O. Backlit Digital Control Panel
- P. Microban® Filtration
- Q. Toploading Skimmer
- R. Pillows
- S. Mood Light

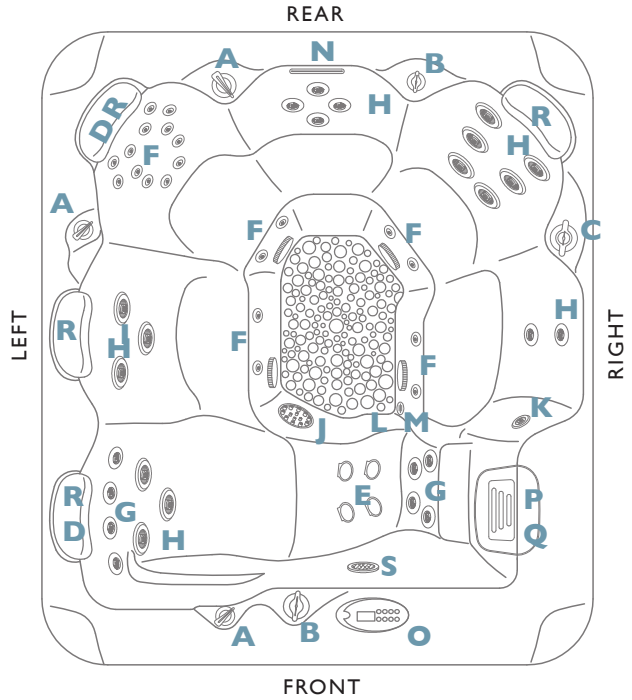

Operations Center

1. (1) Two Speed Hydro Pump
2. (1) Single Speed Hydro Pump
3. 3 kW Heater
4. Purity Circulation™ Pump
5. 230V Power Pack
6. Whisper Zone™ Ozonator- Located behind Purity Circulation™ Pump
7. Drain Valve
8. Mood Light
9. Bonding Terminal
10. Shut- Off Valves
11. Turbo Boost Pump

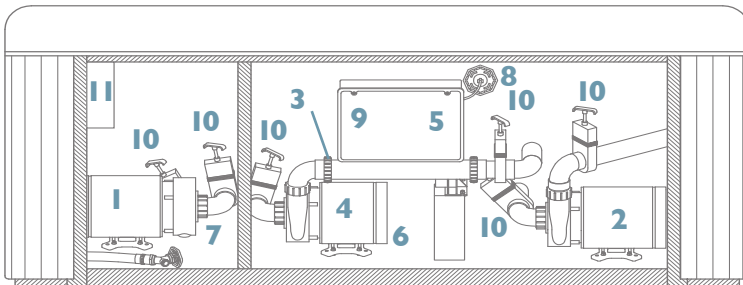

* The Regent is a Special Edition model. Not all Luxury features apply.

LINCOLN

Spa Features

- A. Versa-Flo™ Micro Valves
- B. Air Valves
- C. Roto Stream™ Valves
- D. ProJet Stream™ / Laminar Valves
- E. Power Massage® Jets
- F. ProJet Stream™
- G. Cluster Jets
- H. Standard Jets
- I. Deluxe Jets
- J. Vortex Jet™ Circulation
- K. Whisper Clean® Jet
- L. Footwell Spa Drain
- M. Relax Stream™ Waterfall
- N. Backlit Digital Control Panel
- O. Microban® Filtration
- P. Toploading Skimmer
- Q. Pillows
- R. Mood Light
- S. Satellite Control Button
- T. Laminar Jets

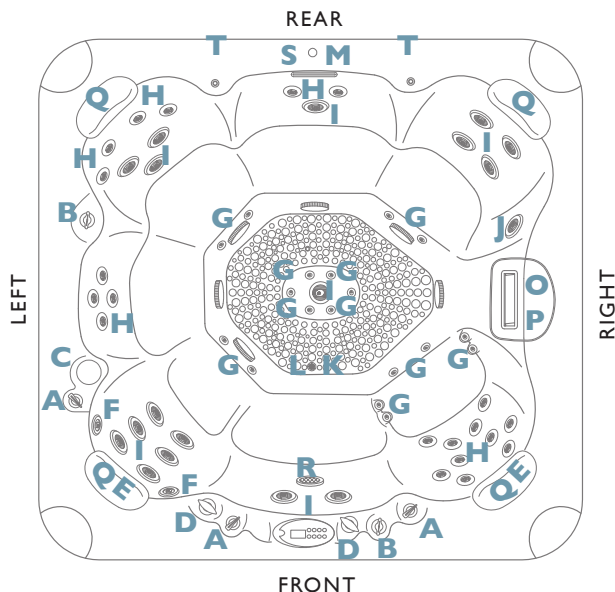

Operations Center

1. (1) Two Speed Hydro Pump
2. (2) Single Speed Hydro Pumps
3. 3 kW Heater
4. Purity Circulation™ Pump
5. 230V Power Pack
6. Whisper Zone™ Ozonator- Located behind Purity Circulation™ Pump
7. Drain Valve
8. Mood Light
9. Bonding Terminal
10. Shut- Off Valves

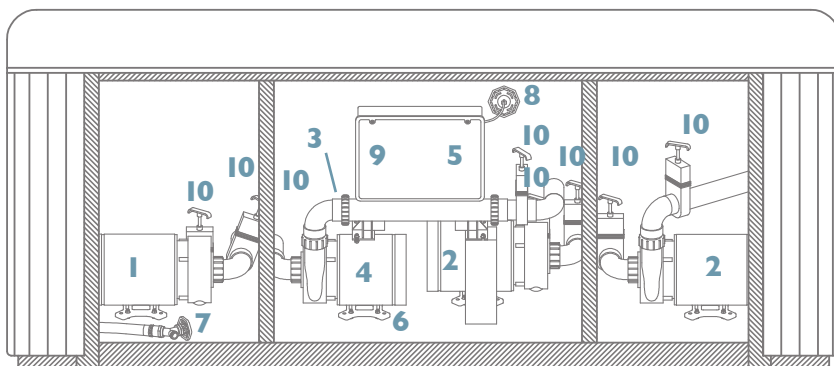

Spa Features

- A. Versa-Flo™ Valves/
Versa-Flo™ Micro Valves
- B. Air Valves
- C. Roto Stream™ Valves
- D. ProJet Stream™ \ Laminar Valves
- E. Power Massage® Jets
- F. Power Stream® Jets
- G. ProJet Stream™
- H. Cluster Jets
- I. Standard Jets
- J. Deluxe Jets
- K. Storm Jets
- L. Master Massage
- M. Vortex Jet™ Circulation
- N. Whisper Clean® Jet
- O. Footwell Spa Drain
- P. Relax Stream™ Waterfall
- Q. Backlit Digital Control Panel
- R. Microban® Filtration
- S. Toploading Skimmer
- T. Pillows
- U. Mood Light
- V. Satellite Control Button
- W. Laminar Jets

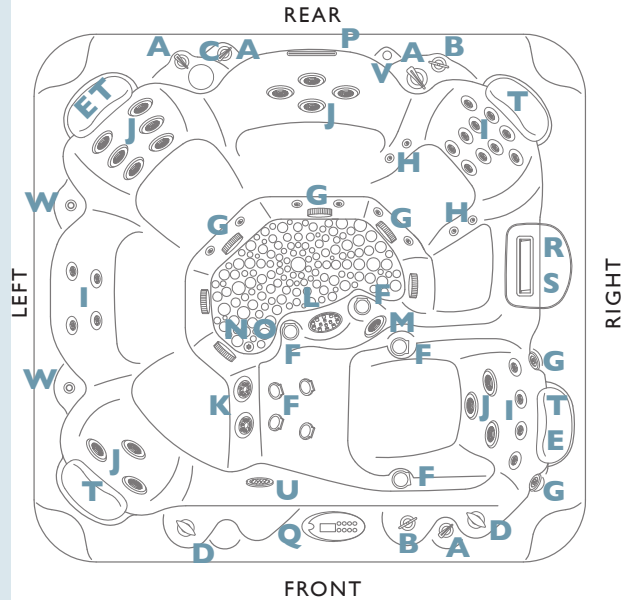

Operations Center

1. (1) Two Speed Hydro Pump
2. (2) Single Speed Hydro Pumps
3. 3 kW Heater
4. Purity Circulation™ Pump
5. 230V Power Pack
6. Whisper Zone™ Ozonator- Located behind the Purity Circulation™ Pump
7. Drain Valve
8. Mood Light
9. Bonding Terminal
10. Shut- Off Valves

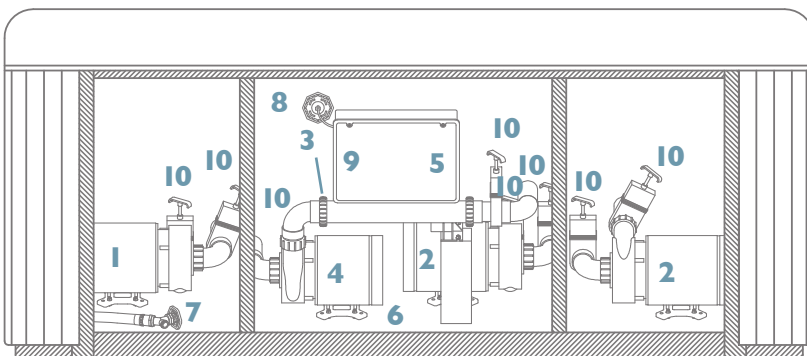

BROADWAY

Spa Features

- A. Versa-Flo™ Valves/
Versa-Flo™ Micro Valves
- B. Air Valves
- C. Roto Stream™ Valves
- D. ProJet Stream™ Valves
- E. Power Massage® Jets
- F. ProJet Stream™
- G. Cluster Jets
- H. Standard Jets
- I. Deluxe Jets
- J. Storm Jets
- K. Turbo Jets
- L. Vortex Jet™ Circulation
- M. Whisper Clean® Jet
- N. Footwell Spa Drain
- O. Relax Stream™ Waterfall
- P. Backlit Digital Control Panel
- Q. Microban® Filtration
- R. Toploading Skimmer
- S. Pillows
- T. Mood Light
- U. Satellite Control Button

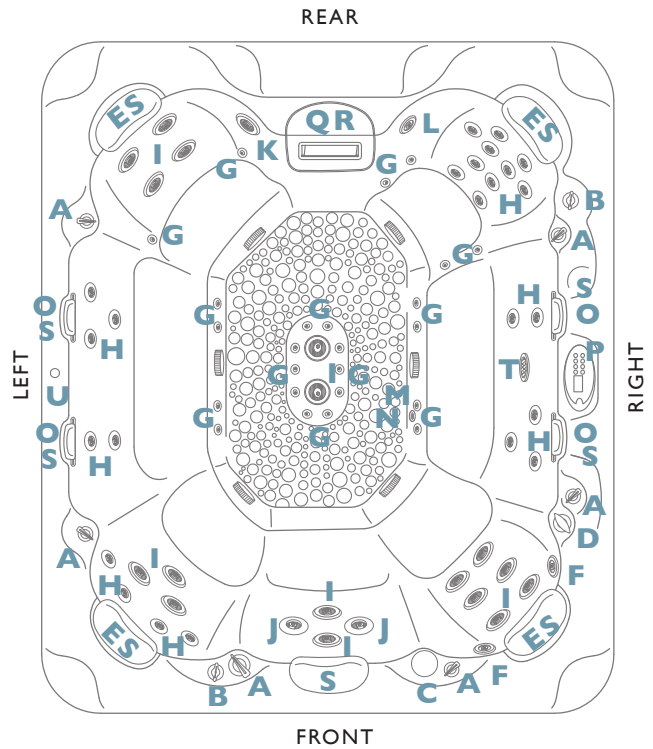

Operations Center

1. (1) Two Speed Hydro Pump
2. (2) Single Speed Hydro Pumps
3. 3 kW Heater
4. Purity Circulation™ Pump
5. 230V Power Pack
6. Whisper Zone™ Ozonator- Located behind the Purity Circulation™ Pump
7. Drain Valve
8. Mood Light
9. Bonding Terminal
10. Shut- Off Valves

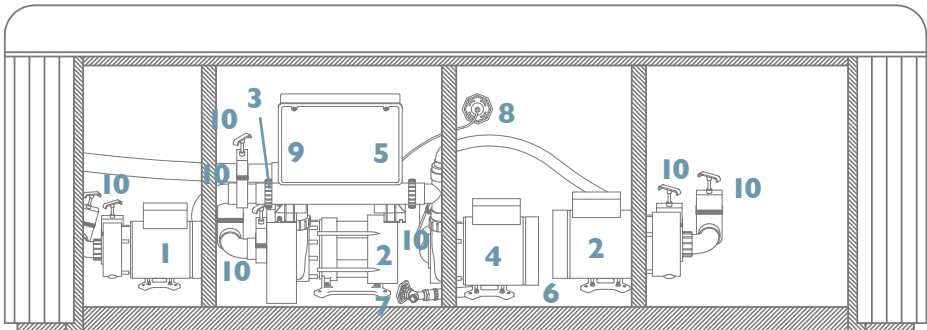

INSTALLATION INSTRUCTIONS

Location Preparation

Your Saratoga Spa® is totally self-contained and portable. You can install the spa outside or inside. Preferable places are on a patio, deck or indoors. The spa should always be placed on a structurally strong, level surface. Other items you need to consider are the following:

- Verify that the location chosen can support the weight of the spa, the water of the spa and its occupants.
- Always check the surface of the site to see if it is level before filling the spa with water.
- Allow access to the equipment compartment for routine maintenance.
- Do not block the air vents found on the face of the equipment compartment.
- When positioning the spa, be sure to allow for drainage away from the electrical compartment.
- Leave easy access to the RCD breaker.
- See page 56 for delivery and moving instructions.



The Saratoga Spa® is manufactured to be a portable unit. Any permanent installation of this product is done at the risk of the owner. Permanent installation of this unit violates warranty coverage.

Outdoor Installation

Always keep in mind what type of climate you live in. In a climate with cold, snowy winters you may want to consider locating the spa close to the house for easy access. In climates where it is normally warm or hot year-round, it would be recommended to place the spa in a shaded or cool area. With deck installations it is recommended that a qualified building contractor or structural engineer review the weight the deck can support. The spa specification sheet (on page 6) can assist you with the weights and dimensions of your spa.

Indoor Installation

Special requirements are needed for indoor installation. Spas normally produce moisture. A ventilation system needs to be considered. Your spa area should contain moisture resistant wall/floor coverings and building materials to avoid damage from moisture over time. Proper drainage of the spa water also needs to be considered.



Your Saratoga Spa® is equipped with air vents to allow for circulation of air throughout the equipment compartment. These vents are found on the face of the equipment compartment panel and under the corners of the spa at the equipment compartment end. Do not allow vents to be blocked as to prevent the circulation of air in the equipment compartment.

Your Saratoga Spa® dealer can help you with information such as local zoning regulations and building codes.

ELECTRICAL REQUIREMENTS AND PRECAUTIONS

Your Saratoga Spa® has gone through numerous tests to verify that all of the spa functions operate. Beyond the tests, your Saratoga Spa® has been designed to provide the maximum safety against electrical shock. Read and follow the electrical installation requirements and instructions completely. The next few pages will assist you in properly connecting the electrical input. Follow the electrical instructions for your specific spa model. Serious risks or injuries may occur if the spa is improperly wired.



230 Volt Permanently Connected Models:

- Polo
- Regent

- Adelphi
- Lincoln

- Putnam
- Empire

- Canfield
- Broadway

Saratoga Spa® models must be wired in accordance with all applicable local electrical codes. All electrical work should be done by an experienced, licensed electrician. We recommend the use of appropriate electrical conduit, fittings and wire for all circuits.

230 Volt installations require a 50Hz, single phase, three-wire electrical service with ground (Line 1, Neutral and Ground) and must be connected using a minimum supply conductor ampacity of 16-32 AMPs and a minimum circuit breaker size of 20 or 40 AMPs.

Note: Use copper wire only (3 wire with ground; 8AWG [8.4mm² gauge] under 50' [15.24m] 6AWG [13.3mm² gauge] over 50' [15.24m]).

230 Volt model spas must be connected to a “dedicated” 230 volt 20 or 40 Amp grounded circuit. The term “dedicated” means the electrical circuit is not being used for any other electrical items (lights, appliances, etc.). If the spa is connected to a non-dedicated circuit, overloading will occur and nuisance tripping of the RCD breaker switch at the house breaker panel will occur.

A ground lug connector is provided on the exterior surface of the spa pack (operations center) inside the equipment compartment. This is to permit the connection of a bonding wire between this point and any metal equipment, enclosures, pipe or conduit within five feet (1.5m) of the spa. This bonding wire must be at least 8AWG [8.4mm²] solid copper wire.



Due to the risk of equipment damage or fire, use only approved pressure-type wire splicing lugs or connectors suitable for the size and type of wiring used.

Electrical Installation Instructions for 230 Volt Models

1. To connect the electrical service, first remove the screws from the equipment compartment door. Carefully remove the access panel.
2. Locate the spa power pack. Loosen the screws on the front of the control box. Remove the screws and the control box cover.
3. Input the electrical service from the RCD breaker into the spa equipment compartment.



The RCD breaker must be placed in sight of the spa, at a minimum distance of five feet (1.5 m) away.

As of January 1, 1996 the National Electric Code (NEC) requires RCD (Residual Current Device) on all spa installations.

4. Connect the supply conduit to the spa power pack.

Electrical Spa Wiring Connection Instructions



Due to the risk of damaging the PC Board, the equipment and the RCD tripping, never, under any circumstances, should you connect power to the neutral terminal.

1. Identify the TB1 terminal block, located inside the spa power pack on the left side.
2. Connect the 8 AWG [8.4mm² gauge], BLUE wire, from the RCD amp breaker, to the BLUE "Neutral" terminal on TB1.
3. Connect the 8 AWG [8.4mm² gauge], BROWN wire, from the RCD amp breaker, to the BROWN "LINE 1" terminal on TB1.
4. Connect the 8 AWG [8.4mm² gauge], YELLOW wire, from the RCD amp breaker, to the YELLOW/GREEN "GROUND" location on the "BONDING LUGS" terminal.
5. At least two additional lugs marked "BONDING LUGS" are provided on the external surface of one of the bonded components metal enclosures. To reduce the risk of electrical shock, connect the local common bonding grid in the area of the hot tub or spa to these terminals with an insulated or bare copper conductor not smaller than No. 6 AWG [13.3mm²].
6. All field-installed metal components such as rail, ladders, drains or other similar hardware within 10 ft (3m) of the spa or hot tub shall be bonded to the equipment grounding bus with copper conductors not smaller than No. 6 AWG [13.3mm²].
7. Replace the control box cover and securely tighten the fastening screws. Close and secure the equipment compartment panel.



Always use copper wire only (3 wire with ground; 8AWG [8.4mm² gauge under 50' [15.24m], 6 gauge [13.3mm² gauge] over 50'[15.24m]. The electrical supply for this product must include a suitable rated switch or circuit breaker to open all ungrounded supply conductors to comply with Section 422.20 of the National Electrical Code ANSI/NEPA 70-1987. The disconnecting means must be readily accessible to the tub occupant but installed at least 5 feet (1.5 m) from tub water



Please review the back of the spa pack cover, located in the spa equipment bay, for a complete spa equipment wiring diagram.

WIRING SCHEMATIC

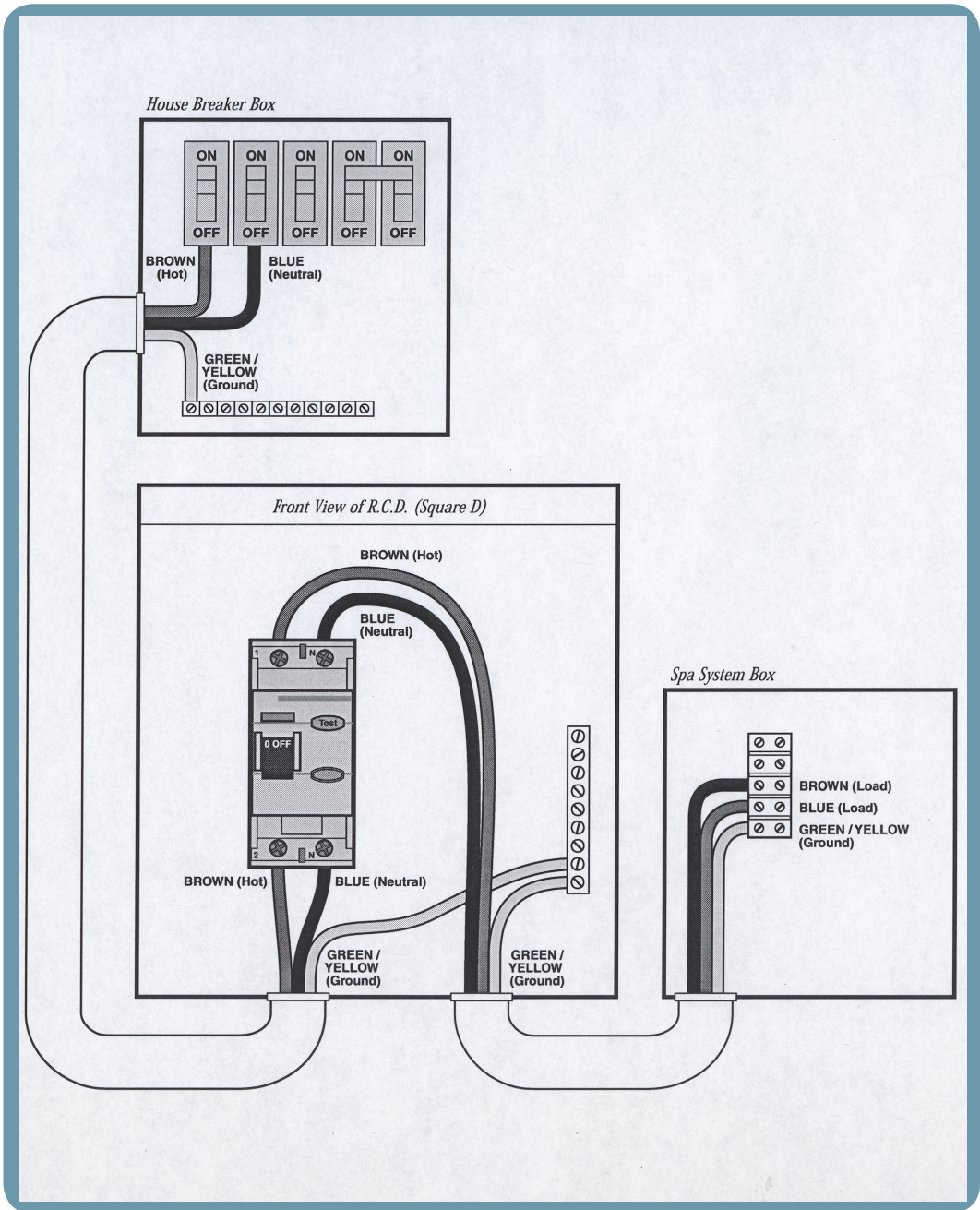

ELECTRICAL SERVICE CONFIGURATION OPTIONS

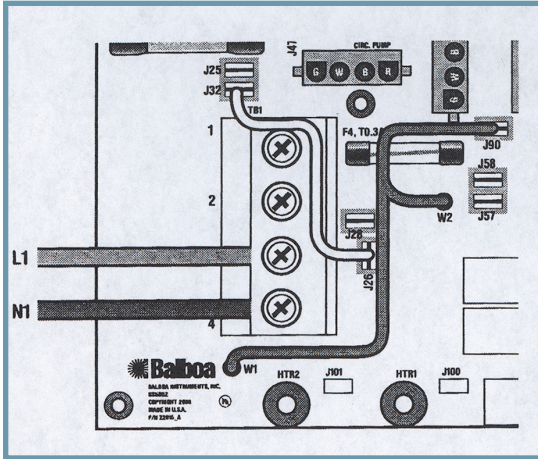

Single Service (1 x 16 Amp or 1 x 32 Amp)

This option is configured and shipped as the default.

- For 1 x 32 Amp Service:
DIP Switch A10 can be ON
- For 1 x 16 Amp Service:
DIP Switch A10 OFF

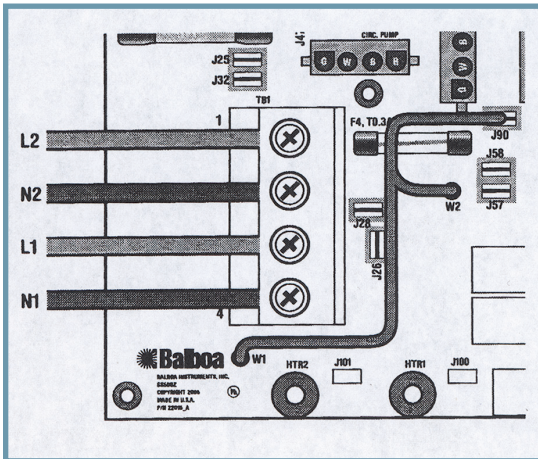

Dual Service Option (2 x 16 Amp)

Completely remove the white wire from J26 and J32.

- Note : J32 and J25 are electrically identical. The white wire may be attached to either terminal before removal.
- DIP Switch A10 must be ON

INITIAL OPERATING INSTRUCTIONS

Start-Up and Refill Procedures

Your Saratoga Spa® has been tested at the manufacturing plant to ensure that all of the spa functions operate. During the test procedure, a small amount of water may have remained in the spa plumbing. Through the shipping process water may have spotted the spa shell. You may need to wipe down the shell with a soft cloth. Please read and follow the start-up instructions to ensure a successful start-up or refill.



- Inspect and clean spa shell of any debris
- Do not turn power on to spa unless filled with water to appropriate level (See Page 21). The spa pack must never be operated without water in the spa; serious damage to the heater and/or pump(s) may result.
- Do not fill spa with water before checking the items below (below items may become loose in transit):

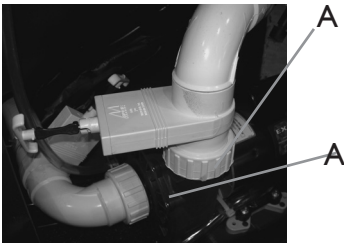

A. Hand tighten unions at the pumps

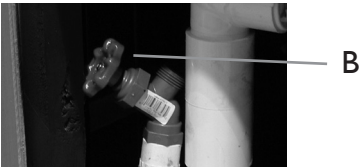

B. Tighten drain valve

Note: Drain Valve is left open for shipping; drain valve must be closed before filling spa.

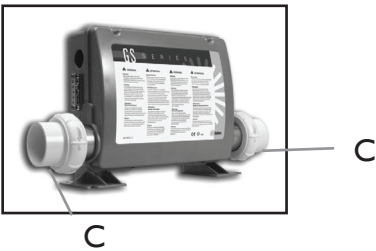

C. Tighten unions on heater

- Do not fill spa with hot water. This may cause a false error code to the temperature sensors.
- Polo & Adelphi Model: Due to the circulation pump sitting vertical in the equipment bay, please fill the spa through the vortex jet to prevent an air lock upon restarting the system.

See page 8, Letter H and #3 for reference.



Start-up Procedures

1. For a successful start-up, fill the spa with water through the Whisper Clean® cartridge. The Whisper Clean® cartridge is the cartridge with the coarse threaded yellow ACME style adapter.

- a. Locate the filter compartment area.

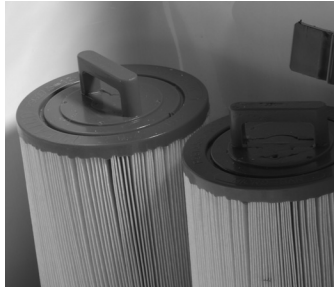

- b. Pull up and remove filter cover.
- c. Remove the filter cartridge and screen adapter by turning them counter clockwise.
- d. After removing each filter cartridge and screen adapter, place a garden hose through the filter opening.
- e. Turn water on and run water until it reaches a minimum level of 2" (5.08cm) above the top of the filters.

Note: Besides filling the spa to 2" (5.08cm) above the top of the filter, all models will need to be filled to 2" (5.08cm) above the highest jet(s) in the spa. This is the minimum level allowed to run the Whisper Clean® circulation system.

Note: When using a mineral cartridge system, please refer to your dealer for specific instructions on installation.

2. Check all plumbing (clamps, unions and drain valve) connections for leaks.
3. Re-install filter cartridges and screen adapters by turning them clockwise. Exit garden hose from the spa.
4. At this point, turn on the spa control system by turning on the RCD breaker. When your spa is first actuated, it will go into Priming Mode, indicated by "dr". During this mode the heater is disabled to allow the priming process to be completed. As soon as "dr" is indicated on the topside panel, push the **Jet(s)** button(s) until the pump(s) are running in high speed. If the pump(s) have been primed continue to step 5. If the pump(s) have not primed after 2 minutes, and water is not flowing from the jets in the spa it may be necessary to manually prime the pump(s) by taking the following steps: First turn the power off on the RCD breaker. Next loosen, but do not remove the union nut on the top most area of the pump(s). Allow for a small amount of water and the trapped air to escape from the pump(s). Once all the air has escaped tighten the union nuts back down. After the pump(s) have been vented, turn on the spa control system by turning on the RCD breaker. The spa will now go back into priming mode.

5. After the pumps are primed turn off by pressing the Jet(s) button(s). Next manually exit the priming mode by pressing either the **Warm** or **Cool** button. After you have manually exited the priming mode the display will show the set temperature, which defaults at 100° F/ 37°C, followed by two dashes (--). This will last for two minutes while the water temperature is determined. Push the **Warm** or **Cool** button to the desired setting.
6. Re-install filter cover and allow spa to heat to desired set temperature: this normally takes 24 hours.
7. Water must be balanced and shocked upon start-up. See your dealer or pages 50-52 of this manual for details. This procedure must be repeated each time the spa is drained and refilled.

8. **The Whisper Clean® Jet**

The combination of the Whisper Clean® and Vortex Jet™ return systems help the Whisper Clean® System to circulate water from the surface and bottom level of the spa. The Whisper Clean® Jet also introduces temperature controlled water and ozone into the spas footwell area 24 hours a day. A slow or non-moving Whisper Clean® Jet may indicate that the filter cartridges are obstructed with dirt, body oils or calcification. Follow the filter cartridge cleaning procedures in this manual.



It is recommended to press and release the Residual Current Device (RCD) RESET button monthly to verify RCD is working properly.

Important:

A pump should not be allowed to run without priming for more than 2 minutes. Under NO circumstances should a pump be allowed to run without priming beyond the end of the 4 minutes priming mode. Doing so may cause damage to the pump and cause the system to go into an overheat condition.



Whisper Clean® Jet

SARATOGA SPA JET IDENTIFICATIONS

VERSA-FLO™ JETS AND CFET™ JET DESCRIPTIONS

Power Massage Plus® and Power Massage®*

Patented jet provides dual water massage to your neck or back from under the built-in headrest. The jet is controlled by a small selector valve, giving the bather total control.

* Provides a single ribbon of water flow parallel to the body



Power Stream®

Underwater jet patterned after the Power Massage®. This jet runs a ribbon of water parallel to the surface of the spa body. Not found in all units.

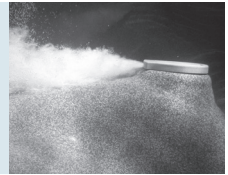

Cluster Jet & Cluster Swirl Jet

The Cluster Jet provides a concentrated stream of water and air for precise pressure point areas. The Cluster Swirl adds a pulsating rotation feel to the pressure point area.

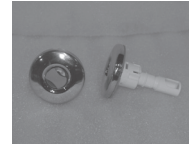

Pro-Jet Stream™

Provides precise neck and shoulder massage. Retractable design is hydro driven and allows for personalized use.

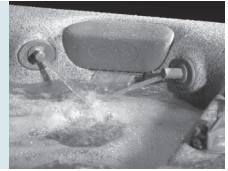

Mini Swirl Jet (Standard Jet Category)

The Mini Swirl Jet has an adjustable eyeball for directional or rotational use. To change from directional to rotational, with finger, simply adjust inner nozzle to the rotating position.



Mini Twin Roto Jet (Standard Jet Category)

This dual nozzle jet gives rotational intensities over focused muscle areas.

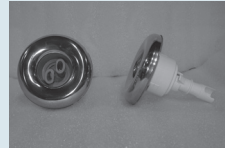

Mini Tri-Flo Massage Jet (Standard Jet Category)

A rotating dual nozzle, diffused by three holes, creates a pulsating body massage.

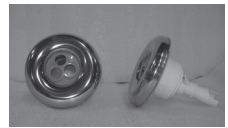

Mini Veri-Flo (Standard Jet Category)

This jet delivers a seven point pressure point flow into the muscle area and has an interchangeable design that gives relief to a variety of areas.



Large Face Mini Swirl and Directional Jet (Standard Jet Category)

The Large Face Mini Swirl Jet has an adjustable eyeball for directional or rotational use. To change from directional to rotational, with finger, simply adjust inner nozzle to the rotating position.



Note: Not all jets are available in all models

Cyclo-Swirl Jet (Deluxe Jet Category)

A larger version of the Mini Swirl Jet, this jet gives a mid-size rotational massage and pulsating massage. To change from directional to rotational, with finger, simply adjust inner nozzle to the rotating position.



Cyclo-Flo Jet (Deluxe Jet Category)

This jet provides a balanced mix of air and water to give a soft, powerful, direct pressure massage to mid-size muscle groups. The design allows for higher GPM for performance and maximum relief.



Dual-Flo Jet (Deluxe Jet Category)

This dual nozzle jet gives a mid-size rotational massage and pulsating massage.



Twin-Roto Jet (Deluxe Jet Category)

The larger version of the Mini-Twin Roto Jet, this jet provides rotational massage over a mid-size muscle areas.

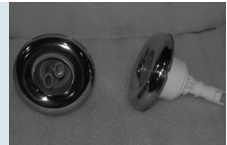

Mini Gatling Jet (Deluxe Jet Category)

The smaller version of the Gatling, a rotating dual nozzle, diffused by seven holes, creates a pulsating body massage.

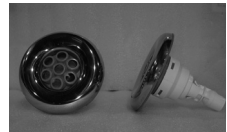

Multi-Flo Jet (Deluxe Jet Category)

The smaller version of the Veri-Flo Jet, this jet delivers multiple pressure point flow into several locations of muscle area and has an interchangeable design that gives relief to a variety of areas.



Xtreme-Flo™ Jet (Storm Jet Category)

The Xtreme Flo jet provides a mix of water and air. The straight stream flows from a larger nozzle for maximum relief.



Gatling Jet (Storm Jet Category)

A rotating dual nozzle, diffused by seven holes, creates a pulsating body massage.



Veri-Flo™ Massage Jet (Storm Jet Category) **& Master-Flo™ Massage Jet**

Multiple pressure point flow, provides foot and large muscle relief. A larger version of the Veri-Flo Massage Jet, the Master-Flo™ Jet delivers multiple pressure point flow into several locations of muscle area and has an interchangeable design that gives relief to a variety of areas.



Turbo Jet

Provides an intense lower body massage and whirlpool stimulation through a large orifice.

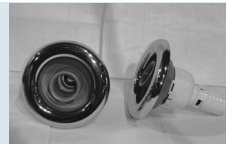

SARATOGA SPA JET SELECTORS

The Jets in the Saratoga Spa® Luxury Line have different ways to adjust the jet therapy systems. While having the Hydro Jet pump(s) on the user has the ability to turn on and off each individual Versa-Flo™ Jet. The Versa-Flo™ Jet(s) can be turned on and off by turning the outer scallop on the face of the jet. In addition to having the ability to control each individual jet, the jets can be adjusted by the following zones.



Versa-Flo™ Air Control Valve

Saratoga Spa® uses six different ways to adjust the jet therapy zones. The Roto Stream™ Valves, ProJet Stream™/Laminar Valves, Versa-Flo™ Valves, and Versa-Flo™ Micro Valves give the user the ability to control the different Jet Therapy Zones. The Air Control valve controls the intensity of the Jets by opening or restricting airflow. The following pages will discuss the different jet therapy zones found in the Luxury Line Spas.

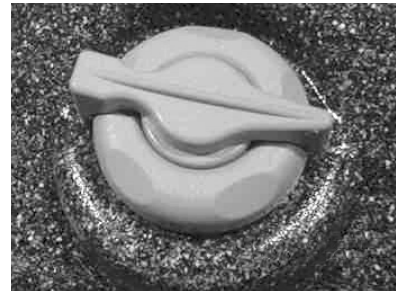

Versa-Flo™ Valve



Roto Stream™ Valve



Versa-Flo™ Micro Valve

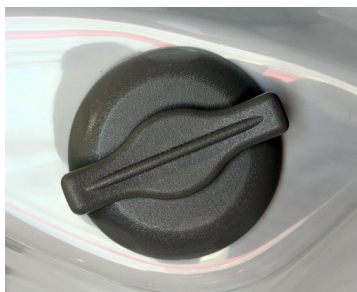

Roto Stream™ Manual Valve

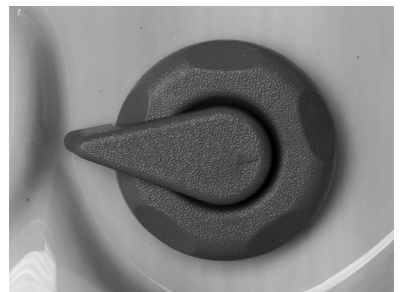

ProJet Stream™ / Laminar Valve

JET SYSTEM MENUS

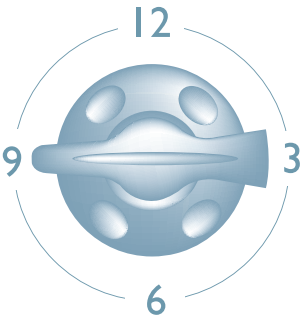

Jet Therapy Zones

This example will help you to understand the following pages that discuss the jet system menus. The navigational tool is read from standing outside of the spa and in front of the particular selector. Keep this in mind when the following pages discuss 12,3,6 or 9 o'clock position settings. The Versa-Flo™ Air Control Valve and Versa-Flo™ Micro Valve can only be rotated 180°. The Project Stream™ Valve controls the Project Stream™ Jets.



POLO

Jet System Menu

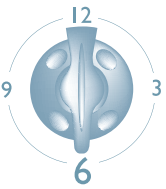
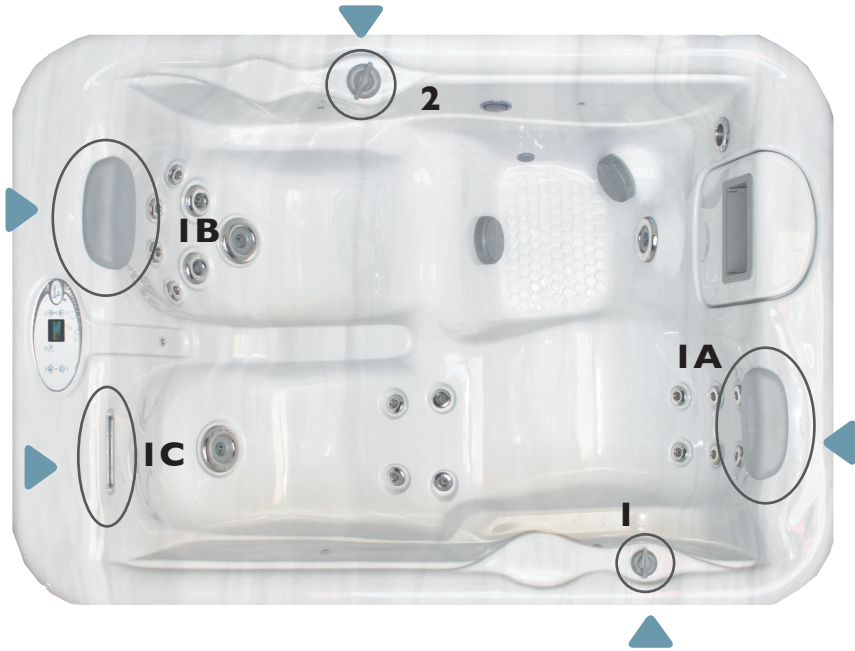

1 | VERSA-FLO™ MICRO VALVE

Controls the amount of water flowing through the Power Massage® Jets IA & IB

- The 3 o'clock position operates a flat stream flow 1A & 1B.
- The 9 o'clock position operates the RelaxStream™ Waterfall 1C
- The 6 o'clock position operates both at a reduced performance.



2 | VERSA-FLO™ AIR CONTROL VALVE

- This Valve adds or restricts intensity to jets when pump(s) are operating.

Note: Descriptions are based upon valve operation from within the spa.

ADELPHI

Jet System Menu

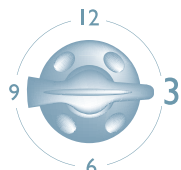

1 | VERSA-FLO™ MICRO VALVE

Controls the amount of water flowing through the Power Massage® Jet 1A

- The 3 o'clock position operates a flat stream flow.
- The 9 o'clock position operates an angled stream flow.
- The 6 o'clock position operates both at a reduced performance.

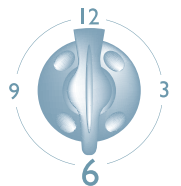

2 | VERSA-FLO™ MICRO VALVE

Controls the amount of water flowing through the Power Massage® Jet 2A & 2B

- The 3 o'clock position operates a flat stream flow 2A.
- The 9 o'clock position operates the RelaxStream™ Waterfall 2B.
- The 6 o'clock position operates both at a reduced performance.

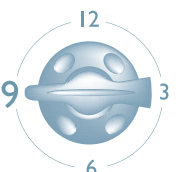

3 | VERSA-FLO™ AIR CONTROL VALVE

- This Valve adds or restricts intensity to jets when pump(s) are operating.

Note: Descriptions are based upon valve operation from within the spa.

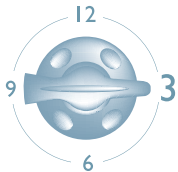

1 | VERSA-FLO™ MICRO VALVE

Controls the amount of water flowing through the Power Massage® Jet & RelaxStream™ Waterfall 1A & 1B}

- The 3 o'clock position operates a flat stream flow 1A.
- The 9 o'clock position operates the RelaxStream™ Waterfall 1B.
- The 6 o'clock position operates both at a reduced performance.

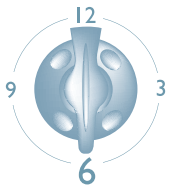

2 | VERSA-FLO™ MICRO VALVE

Controls the amount of water flowing through the Power Massage® Plus Jet 2A

- The 3 o'clock position operates an angled stream flow.
- The 9 o'clock position operates a flat stream flow.
- The 6 o'clock position operates both at a reduced performance.

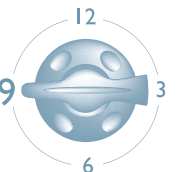

3 | VERSA-FLO™ AIR CONTROL VALVE

- This Valve adds or restricts intensity to jets when pump(s) are operating.

Note: Descriptions are based upon valve operation from within the spa.

CANFIELD

Jet System Menu

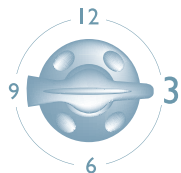

1 | VERSA-FLO™ MICRO VALVE

Controls the amount of water flowing through Jets in 1A & 1B

- The 3 o'clock position operates the RelaxStream™ Waterfall 1A.
- The 9 o'clock position operates a flat stream flow 1B. .
- The 6 o'clock position operates both at a reduced performance.

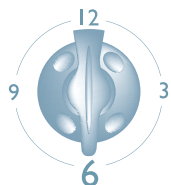

2 | VERSA-FLO™ MICRO VALVE

Controls the amount of water flowing through the Power Massage® Plus Jet 2A

- The 3 o'clock position operates an angled stream flow.
- The 9 o'clock position operates a flat stream flow
- The 6 o'clock position operates both at a reduced performance.

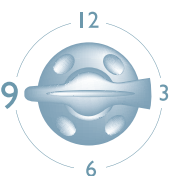

3 | VERSA-FLO™ VALVE

Controls the amount of water flowing through Jets in 3A & 3B

- The 3 o'clock position operates the foot dome jet flow 3A.
- The 9 o'clock position operates the 12 jet seat flow 3B.
- The 6 o'clock position operates both at a reduced performance.

*4 | ROTO-STREAM™ MICRO VALVE

Controls the Roto Stream™ Valves 4A sequencing speed to the 6 jets in the Roto Stream™ Seat 4B

- The 3 o'clock position turns off the Roto Stream™ valve 4A from sequencing the six jets in seat 4B.
- The 9 o'clock position turns on the Roto Stream™ valve 4A and begins sequencing the six jets in seat 4B.

5 | VERSA-FLO™ AIR CONTROL VALVE

- This Valve adds or restricts intensity to jets when pump(s) are operating.

Note: Descriptions are based upon valve operation from within the spa.

REGENT SPECIAL EDITION

Jet System Menu

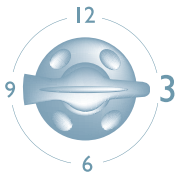
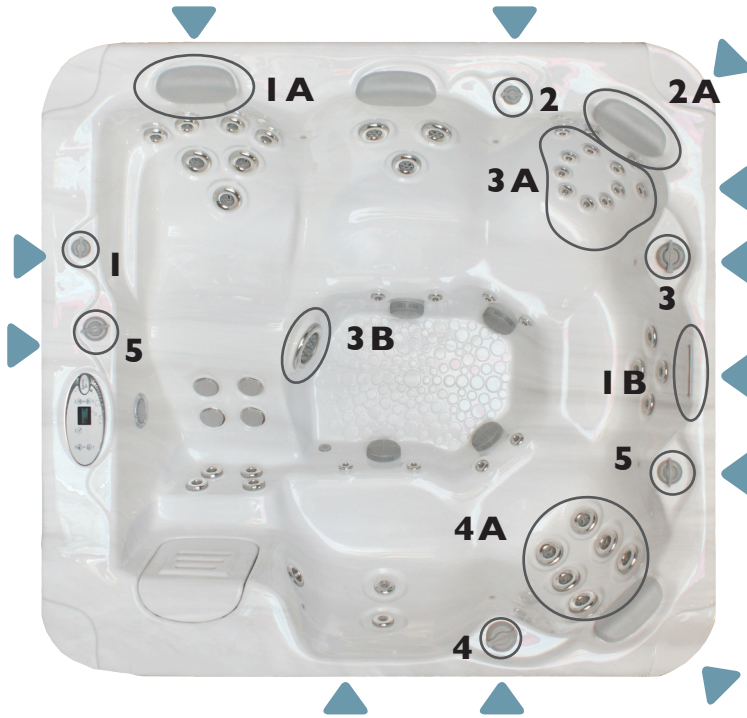

1 | VERSA-FLO™ MICRO VALVE

Controls the amount of water flowing through the Power Massage® Jet & RelaxStream™ Waterfall 1A & 1B

- The 3 o'clock position operates a flat stream flow 1A.
- The 9 o'clock position operates the RelaxStream™ Waterfall 1B.
- The 6 o'clock position operates both at a reduced performance.

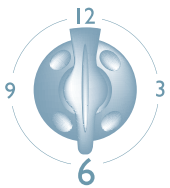

2 | VERSA-FLO™ MICRO VALVE

Controls the amount of water flowing through the Power Massage® Plus Jet 2A

- The 3 o'clock position operates an angled stream flow.
- The 9 o'clock position operates a flat stream flow
- The 6 o'clock position operates both at a reduced performance.

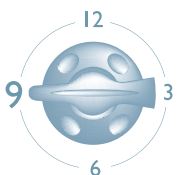

3 | VERSA-FLO™ VALVE

Controls the amount of water flowing through Jets in 3A & 3B

- The 3 o'clock position operates the 12 jet seat flow 3A.
- The 9 o'clock position operates the foot dome jet flow 3B.
- The 6 o'clock position operates both at a reduced performance.

4 | ROTO-STREAM™ MANUAL VALVE

Controls the Roto Stream™ sequencing speed to the 6 jets in the Roto Stream™ Seat 4A

5 | VERSA-FLO™ AIR CONTROL VALVE

- This Valve adds or restricts intensity to jets when pump(s) are operating.

Note: Descriptions are based upon valve operation from within the spa.

Note: The Regent has the Roto Stream™ Sequencing System as an optional feature. The manual version of the Roto Stream™ is a standard feature on the Regent.

LINCOLN

Jet System Menu

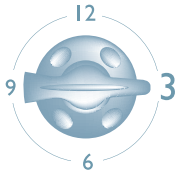

1 | VERSA-FLO™ MICRO VALVE

Controls the amount of water flowing through the Power Massage® Jet & RelaxStream™ Waterfall 1A & 1B

- The 3 o'clock position operates a flat stream flow 1A.
- The 9 o'clock position operates the RelaxStream™ Waterfall 1B.
- The 6 o'clock position operates both at a reduced performance.

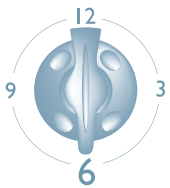

2 | VERSA-FLO™ MICRO VALVE

Controls the amount of water flowing through the Power Massage® Plus Jet 2A

- The 3 o'clock position operates an angled stream flow.
- The 9 o'clock position operates a flat stream flow
- The 6 o'clock position operates both at a reduced performance.

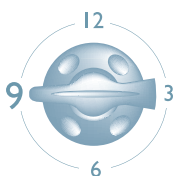

3 | PROJET STREAM™ / LAMINAR VALVE

Controls the operation of the ProJet Stream™ Jets 3A & 3B

- Rotating the ProJet Stream™ / Laminar Valve completely counter clockwise opens water flow to the ProJet Stream™ / Laminar Jets.
- Rotating the ProJet Stream™ / Laminar Valve completely clockwise closes the water flow to the ProJet Stream™ / Laminar Jets.

4 | ROTO-STREAM™ MICRO VALVE

Controls the Roto Stream™ Valves 4A sequencing speed to the 6 jets in the Roto Stream™ Seat 4B

- The 3 o'clock position turns off the Roto Stream™ valve 4A from sequencing the six jets in seat 4B.
- The 9 o'clock position turns on the Roto Stream™ valve 4A and begins sequencing the six jets in seat 4B.

5 | VERSA-FLO™ AIR CONTROL VALVE

- This Valve adds or restricts intensity to jets when pump(s) are operating.

EMPIRE

Jet System Menu

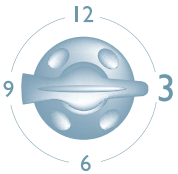

1 | VERSA-FLO™ MICRO VALVE

Controls the amount of water flowing through the Power Massage® Jet & RelaxStream™ Waterfall 1A & 1B

- The 3 o'clock position operates a flat stream flow 1A.
- The 9 o'clock position operates the RelaxStream™ Waterfall 1B.
- The 6 o'clock position operates both at a reduced performance.

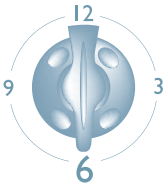

2 | PROJET STREAM™ / LAMINAR VALVE

Controls the operation of the ProJet Stream™ / Laminar Jets 2A & 2B

- Rotating the ProJet Stream™ / Laminar Valve completely counter clockwise opens water flow to the ProJet Stream™ / Laminar Jets.
- Rotating the ProJet Stream™ / Laminar Valve completely clockwise closes the water flow to the ProJet Stream™ / Laminar Jets.

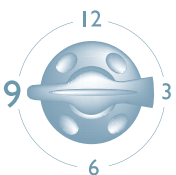

3 | VERSA-FLO™ MICRO VALVE

Controls the amount of water flowing through the Power Massage® Plus Jet 3A

- The 3 o'clock position operates a flat stream flow
- The 9 o'clock position operates an angled stream flow.
- The 6 o'clock position operates both at a reduced performance.

***4 | ROTO-STREAM™ MICRO VALVE**

Controls the Roto Stream™ Valves 4A sequencing speed to the 6 jets in the Roto Stream™ Seat 4B

- The 3 o'clock position turns on the Roto Stream™ valve 4A and begins sequencing the six jets in seat 4B.
- The 9 o'clock position turns off the Roto Stream™ valve 4A from sequencing the six jets in seat 4B.

5 | VERSA-FLO™ VALVE

Controls the amount of water flowing through Jets in 5A & 5B

- The 3 o'clock position operates the foot dome jet flow 5A.
- The 9 o'clock position operates the 14 jet seat flow 5B.
- The 6 o'clock position operates both at a reduced performance.

6 | VERSA-FLO™ AIR CONTROL VALVE

- This Valve adds or restricts intensity to jets when pump(s) are operating.

BROADWAY

Jet System Menu

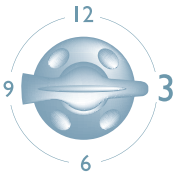
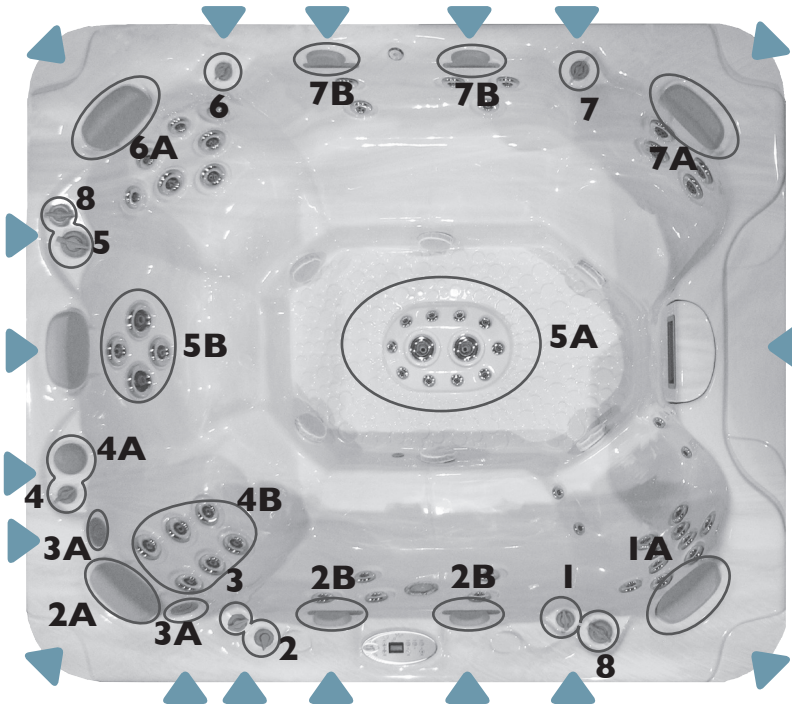

1 | VERSA-FLO™ MICRO VALVE

Controls the amount of water flowing through the Power Massage® Plus Jet 1A

- The 3 o'clock position operates an angled stream flow.
- The 9 o'clock position operates a flat stream flow
- The 6 o'clock position operates both at a reduced performance.

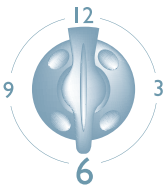

2 | VERSA-FLO™ MICRO VALVE

Controls the amount of water flowing through the Power Massage® Jet & (2) RelaxStream™ Waterfalls 2A & 2B

- The 3 o'clock position operates a flat stream flow 2A.
- The 9 o'clock position operates (2) RelaxStream™ Waterfalls 2B.
- The 6 o'clock position operates both at a reduced performance.

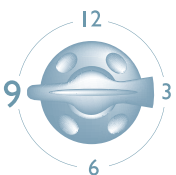

3 | PROJET STREAM™ VALVE

Controls the operation of the ProJet Stream™ Jets 3A

- Rotating the ProJet Stream™ Valve completely counter clockwise opens water flow to the ProJet Stream™ Jets.
- Rotating the ProJet Stream™ Valve completely clockwise closes the water flow to the ProJet Stream™ Jets.

•4 | **ROTO-STREAM™ MICRO VALVE**

Controls the Roto Stream™ Valves 4A sequencing speed to the 6 jets in the Roto Stream™ Seat 4B

- The 3 o'clock position turns off the Roto Stream™ valve 4A from sequencing the six jets in seat 4B.
- The 9 o'clock position turns on the Roto Stream™ valve 4A and begins sequencing the six jets in seat 4B.

5 | **VERSA-FLO™ VALVE**

Controls the amount of water flowing through Jets in 5A & 5B

- The 3 o'clock position operates the foot dome jet flow 5A.
- The 9 o'clock position operates the 4 jet seat flow 5B.
- The 6 o'clock position operates both at a reduced performance.

6 | **VERSA-FLO™ MICRO VALVE**

Controls the amount of water flowing through the Power Massage® Plus Jet 6A

- The 3 o'clock position operates a flat stream flow
- The 9 o'clock position operates an angled stream flow.
- The 6 o'clock position operates both at a reduced performance.

7 | **VERSA-FLO™ MICRO VALVE**

Controls the amount of water flowing through the Power Massage® Jet & (2) RelaxStream™ Waterfalls 7A & 7B

- The 3 o'clock position operates a flat stream flow 7A.
- The 9 o'clock position operates (2) RelaxStream™ Waterfalls 7B.
- The 6 o'clock position operates both at a reduced performance.

8 | **VERSA-FLO™ AIR CONTROL VALVE**

- This Valve adds or restricts intensity to jets when pump(s) are operating.

EQUIPMENT MAINTENANCE

Saratoga Spa® Jet Valve Maintenance

After a period of time it may become difficult to adjust and rotate the valves. It is necessary to clean the valves to ensure that they continue to perform well. The following instructions will walk you through the steps.

1. Turn power off to the spa.
2. Un-thread valve cover by turning valve cover counter clockwise.
3. Remove complete valve assembly, by pulling outward.
4. Clean or remove debris from valve or diverter.
5. Re-assemble and re-thread valve cover.



Roto Stream™ Valve Maintenance*

The Roto Stream™ valve is another unique feature that Saratoga Spa uses for Hydrotherapy. It is necessary to clean the valve to ensure that the Roto Stream™ valve continues to perform well. The following instructions will walk you through the steps in cleaning the valve and cleaning the built in cup strainer. It is recommended to clean the Roto Stream™ valve every time you drain your spa.

***Luxury Version:** Canfield, Lincoln, Empire, Broadway

***Special Edition Version:** Regent



Roto Stream™ Valve Cleaning

1. Turn power off to the spa.
2. Unthread Roto Stream™ Valve cover by turning valve cover counter clockwise.
3. Remove complete Roto Stream™ Valve assembly by pulling outward.
4. Remove and clean free of any debris in and on strainer screen and valve assembly.
5. Re-assemble and re-thread Roto Stream™ Valve into place.

Replacing the Spa Color Blast™ LED Light

The spa Color Blast™ LED Light is located inside of the equipment compartment. Remove the front access panel by first removing the screws on the access panel. Then locate the light housing mounted to the spa shell. Use a flathead screwdriver, placed into slot on back of light housing, turn and remove light housing and remove LED Color Blast™ light fixture. Install replacement LED Color Blast bulb unit (available from your Saratoga Spa® dealer). Then re-attach light niche into light housing and close equipment compartment by securing the access panel.

CONTROL PANEL FUNCTIONS

MAIN CONTROL PANEL

The panel/topside will indicate the operations of the hydro jet pump(s), spa light, water temperature and will display diagnostic symbols.

Saratoga Spa® models are equipped with a main control panel located on the top collar of the spa. The main control panel controls all of the spa functions. It displays the spa's status and any diagnostic messages. The main control panel and digital display are illuminated by a light from the inside of the panel.

The Lincoln, Empire, and Broadway models have an additional satellite panel located across from the main control panel that allows the spa user to operate the Jets 2 function from the other side of the spa.

MAIN CONTROL PANEL BUTTONS AND DIGITAL DISPLAY

The main control panel has buttons which the spa user presses to set the temperature, vary the intensity of the light and activate or deactivate the hydro jet pump(s). The control panel also has a digital display that displays the spa diagnostics (ie-temperature setting, jet functions or error messages).

Temperature Control

The set temperature range is from 80°F (26°C) to 104°F (40°C). The temperature of the spa water will automatically be 100°F (37°C) the first time that power is applied. This is the default temperature setting programmed at the factory.

To display the set temperature of the spa, press the **Warm** or **Cool** button once.

To raise the set temperature of the spa, press the **Warm** button a second time. Each press of the **Warm** button will continue to raise the set temperature.

To lower the set temperature of the spa, press the **Cool** button a second time. Each press of the **Cool** button will continue to the lower set temperature.

Note: When first powered up the water temperature will not be displayed until the pump has been running for at least two minutes.

Note: The temperature shown on the display without pressing the Warm or Cool button reflects the temperature of the water at that particular moment.

OPERATING THE HYDRO PUMPS

Jets 1 Button

Activates the hydro jet pump #1 for maximum hydrotherapy jet action. Press the **Jets 1** button once for low speed, again for high speed and again to turn the pump off. When the pump is activated the indicator above the **Jets 1** button will light up. The pump will turn off automatically after 15 minutes on high speed and 4 hours on low speed.

Jets 2 Button

Activates the hydro jet pump #2 for maximum hydrotherapy jet action. Press the **Jets 2** button once for high speed and again to turn the pump off. When the pump is activated the indicator above the **Jets 2** button will light up. The pump will turn off automatically after 15 minutes on high speed.

Jets 3 Button

(Empire, Lincoln, and Broadway Only)

Activates the hydro jet pump #3 for maximum hydrotherapy jet action. Press the **Jets 3** button once for high speed and again to turn the pump off. When the pump is activated the indicator above the Jets 3 button will light up. The pump will turn off automatically after 15 minutes on high speed.

Note: The spa light will begin flashing 15 seconds before the pumps shut off as a reminder, that the pump(s) cycle is about to end.

Note: The Polo, Adelphi, Putnam, Canfield and Regent Special Edition are equipped with a Turbo Boost Pump. When activated, this pump forces air into the plumbing lines to increase pressure through the jetting.

Note: The Polo and Adelphi models only have 2 jet buttons on the panel.

Note: Saratoga Spas® models are designed for maximum heat retention. The unit is not designed to cool water. If the set or desired temperature is below that of the ambient temperature, the unit will not be able to achieve this demand. Depending on the desired temperature, it may be necessary to add cool water to the unit to lower your spas water temperature.

Turbo Boost Pump

The Turbo Boost Pump feature forces more air into the jet plumbing lines giving added hydrotherapy performance and intensity through the jetting in the spa. The **Jets 2** operates the Turbo Boost on the Polo & Adelphi, **Jets 3** on the Putnam, Canfield and Regent Special Edition. The Turbo Boost Pump is not available on the Empire, Lincoln and Broadway. The **Jets 3** button on these models runs the third pump.

Note: The Turbo Boost is not designed as a stand alone therapy option and will produce very little performance though jetting without **Jets 1** and/or **Jets 2** operating simultaneously with it.



Light Control Button - Luxury Splash Lighting System

The Luxury Splash Lighting System is designed to give the user multiple color options and styles. To turn on the system, press the light button. The spa will illuminate with one of its many combinations and locations. As you continue to press the light button, different color combinations and illuminating styles, such as solid, fading or pulsating color will function. You must press the light button through each function before it reaches the off mode. If the light is left on it will automatically be turned off by the control system after four hours of continuous operation.

Optional Luxury Sound System

See operational features and instructions located with the MP3 Ready/FM Tuner or Bluetooth Streaming System, or contact your dealer for instructions.

HEATING MODES

Mode is changed by pressing the **Warm** or **Cool** button, then pressing the **Mode** button. The heating modes "do not" control the circulation pump. It only controls the way the spas will heat and during what time of day.

Standard Mode is programmed to maintain the desired temperature continuously, thermostatically on a daily basis. Note that the last measured spa temperature displayed is current only when the pump has been running for at least 2 minutes. "Std" will be displayed momentarily when you switch into Standard Mode.

Economy Mode heats the spa to the set temperature only during your chosen economy mode cycles, as needed. "Ecn" will display solid when temperature is not current, and will alternate with temperature when temperature is current. You can choose 2, 4, 6 or 8 hours of heat option during a 12 hour time frame. If you choose 2 hours on then the heat option will be off for 10 hours. Then on for 2, then off for 10, and so on. This is not a filtration cycle but a time frame you choose to allow the spa to heat if needed.

Sleep Mode heats the spa within 20°F/10°C of the set temperature only during filter cycles. "SLP" will display solid when temperature is not current, and will alternate with temperature when temperature is current. This cycle is designed when the spa will not be used for long periods of time. Water sanitizing and balance will still be necessary even if the spa is not being used.

Note: The last measured spa temperature displayed is current only when the pump has been running for at least 2 minutes.

FILTER CYCLE MODES

Saratoga Spa® has designed its continuous circulation pump system to operate without manual programming. The continuous circulation pump operates unless interrupted by a system diagnostic or automated program, or by a power failure. With the continuous circulation system, manual filter cycles do not apply. The spa is designed to continuously circulate the water.

Freeze Protection

If the temperature sensors detect a drop to below 44°F/6.7°C within the heater, the pumps will automatically activate to provide freeze protection. The equipment stays on until 4 minutes after the sensors detect that the spa temperature has risen to 45°F/7.2°C or higher.

Summer Set Mode

Your spa is equipped with this feature to prevent heat build up. Summer Set Mode is activated when the water temperature exceeds the set temperature by 3°. When the Summer Set Mode is activated it will suspend the filter cycle for 30 minutes, then Pump 1 will run on low speed for 2 minutes. It will continue this way until the water temperature returns to the set temperature.

Automated Purge Cycle

Every 12 hours the Jet Pump(s) will engage. Pump 1 on low speed, and on selected models Pumps 2 and Pumps 3 on high speed for a duration of 5 minutes. This process purges the jet plumbing lines twice daily, making sure water in the plumbing lines is moved out into the spas main body of water.

SATELLITE PANEL (EMPIRE, LINCOLN, AND BROADWAY ONLY)

This smaller satellite panel is located on the spa collar opposite the main panel/topside control. All the features that are available for Jets 2 are accessible by using this smaller satellite panel. Temperature and light functions are not accessible through the smaller satellite panel.



SPA CARE AND WATER MAINTENANCE

GENERAL INFORMATION

Your Saratoga Spa® is manufactured from the highest quality, most durable materials available today. We recommend that a spa maintenance program be followed. The care you take will ultimately determine how long your spa or its individual components will last. This section will help you maintain your investment.

Replacing The Water

Proper spa maintenance (regular draining and replacing of spa water according to these directions along with filter cleaning), proper spa water treatment (water balance and maintaining correct sanitizer levels), and proper installation (adequate ventilation) are the keys to ensuring sanitary, healthy spa water.

It is recommended that you completely drain your spa every 45 to 90 days. Normally, after a period of time the water will become sudsy and harder to maintain and should be replaced. The NSPI WRI, Water Replacement Interval Formula is as follows:

$$\text{WRI} = \frac{.33 \times \text{Spa Volume in US Gallons}}{\text{Average Bathers per Day}}$$

Note: Convert gallons to Litres by: US gallons x 3.785 = Total Litres

Note: Heavy usage may require more frequent draining.

To Drain Your Spa:

1. Disconnect the spa from the power supply by tripping the RCD breaker located in the house breaker panel or at the RCD disconnect breaker at the spa.
2. Take off the equipment access panel by first removing the screws and then pulling out the access panel. Locate main drain valve and attach the inlet of a garden hose to the drain valve. Route garden hose to an appropriate draining area away from the spa to avoid flooding of the surroundings around the spa.

Note: Spa water with a high sanitizer level may harm plants and grass.

3. Open the drain valve by turning the knob. The spa will drain by gravitational flow.
4. Saratoga Spa® models will drain to the lower suction fittings in the footwell of the spa. It may be necessary to vacuum or sponge up a small amount of the remaining water in the spa.
5. When empty, inspect the spa shell and clean as required.
6. Close the drain valve and remove garden hose.
7. Replace or close the equipment access door and replace screws.
8. Refill the spa through the filter compartment BEFORE restoring power.

Important:

Always clean the filter cartridges each time the spa is drained for cleaning.

Filter System

Saratoga Spa® is equipped with long (16.5"/42cm) filter cartridges, except on the Polo and Adelpi, which have standard (12"/30cm) filters. As with any filtering system, the filter cartridges may become clogged with particles, body oils or calcification resulting in poor water quality and reduced water flow. It is important to maintain a clean, unobstructed filtering system. A reduced water flow may cause failure of the circulation pump or for the circulation pump to shut down. If the circulation of water stops during sub-freezing temperatures and goes unnoticed, the spa water may freeze, which is not covered under manufacturer's warranties.

Important:

The frequency and duration of use, and the number of occupants, all contribute to determining the appropriate time between filter cleanings. More use means that more frequent filter cleanings are required. Failure to maintain the cartridges in a clean, unobstructed manner will result in reduced water flow. Any damage to the spa due to freezing or caused as a result of poor maintenance will not be covered by your spa warranty.

FILTER CARTRIDGE REMOVAL AND CLEANING

1. Disconnect the spa from the power supply by tripping the RCD breaker at the spa.
2. Remove and carefully set aside the filter compartment cover.
3. Remove any floating items from within the filter compartment.
4. Grasp the handle of the filter cartridge and turn the cartridge clockwise until it is free from the base retainer. Leave screen adapter in place.
5. Place the cartridge on a clean surface and spray with a garden hose. It will be necessary to rotate the cartridge(s) to ensure all the filter pleats have been cleaned.

6. Continue cleaning by spraying down throughout the center of the cartridge (inside out).
7. For a complete and more thorough cleaning it is recommended to soak cartridges in a filter cleaning solution. Follow directions on the filter cleaner label.
8. Before inserting cartridges, do a final inspection of the cartridges.
9. To reinstall the filter cartridges, reverse the order in which the cartridges were removed.

Important:

Do not turn power on or use the spa with the filter cartridges or screen adapters removed!

Note: Spa cartridges are a disposable item and should be replaced each year.

CARE OF THE SPA PILLOWS

The spa pillows used on Saratoga Spa® models will provide years of comfort if treated with care. To extend their life the spa pillows should be removed and cleaned. Wash with a mild soap and water solution. ALWAYS rinse off the spa pillows thoroughly to remove any soap residue. If the spa is not going to be used for a long period of time the spa pillows should be removed until the next spa use.

To remove and replace the spa pillows:

1. Carefully lift one end of the pillow away from the spa shell.
2. Continue lifting one end until it is released from the attachment bar on the spa shell. Do the same to loosen the other end of pillow. To reinstall the spa pillow, carefully bend the pillow slightly to allow the slit on the back of the pillow to slip over the attachment bar retainer on the spa shell.
3. After the pillow slips over the attachment, press the pillow down into the recess in the spa shell.

Important:

Just pulling the pillow straight up and off of the attachment bar will eventually damage the pillow. This abuse is not covered under warranty.

CARE OF THE EXTERIOR

Spa Shell

Your Saratoga Spa® is manufactured with a tough acrylic surface. Some staining or water marking may occur at or above the water surface. Removal of these surface conditions can usually be accomplished with a soft cloth by merely wiping them away. Stubborn stains can be removed first by draining the spa and then using a nonabrasive product. Always thoroughly rinse off any spa shell cleaning agent with fresh water.



Keep all cleaners out of the reach of children and use care when applying.

Spa Cabinet

The skirt around your Saratoga Spa® is manufactured with the finest quality material and is available in a low maintenance exterior.

WeatherAll™ Skirt

The WeatherAll™ skirt combines the durability of plastic with the look of professionally finished wood. To remove any stains or dirt simply spray the skirt with water and wipe down with a soft cloth. WeatherAll™ is not designed to be stained or resealed.

Note: WeatherAll™ could experience natural fading due to sunlight and weather exposure. This condition is not covered under warranty.

CARE OF THE SPA COVER

Vinyl Cover

Your vinyl thermal spa cover has been designed for your particular spa. Monthly cleaning and conditioning is recommended to maintain its beauty.

To clean and condition the vinyl cover:

1. Remove the cover from the spa and gently lean it against a wall or fence.
2. With a garden hose, spray the cover to loosen and rinse away dirt or debris.
3. Using a large, non-abrasive sponge and using a very mild soap solution (one teaspoon dishwashing liquid with two gallons of water) scrub the vinyl top in a circular motion. Make sure to rinse all soap off the cover before it dries.
4. Scrub the cover's perimeter and side flaps. Rinse clean with water.
5. Rinse off the underside of the cover with water only (use no soap), and wipe it clean with a dry rag.
6. To condition the cover after cleaning, apply a thin film of saddle soap (follow directions on the container) or vinyl conditioning cream.

Important reminders:

- **Do** unlock and release all cover locks before attempting to open cover.
- **Do** remove snow buildup to avoid damage of the foam core from the additional weight of the snow (not covered under warranty).
- **Do** lock cover lock straps to secure the cover when the spa is not in use.
- **Do not** drag or lift the spa cover using either the flaps, or the cover tie downs.
- **Do not** walk, stand, or sit on the cover.

Important:

Whenever the spa is not in use it is essential that the thermal cover be kept in place. When filled this ensures effective temperature maintenance and economical operation. When empty this prevents potential damage to the spas surface finish which can result from excessive heat caused by the sun. This type of damage is specifically excluded from warranty protection. It is recommended that the thermal cover tie downs always be used to discourage access to the spa by unsupervised children and minimize heat loss.

*The spa cover manufacturer handles all warranty claims. Saratoga Spa® does not handle any warranty issues on the spa cover. Every Saratoga Spa® is equipped with a locking cover that meets the ASTM F1346-91 standard for safety covers.

WINTERIZING YOUR SPA

If you chose not to use your Saratoga Spa® during the winter, it is recommended to properly winterize your spa. Any damage occurring due to accidental freezing of the spa is not covered under warranty.

The following steps are designed to protect your spa from freezing if followed. For ultimate protection against freeze damage to your spa, contact your local Saratoga Spa® Dealer to schedule a winterizing service plan.

1. Turn power off to the spa. Trip RCD breaker.
2. Unscrew panel screws. Remove access panel.
3. Locate the drain valve and attach a garden hose to the drain valve.
4. Open the drain valve and allow the water to drain (Saratoga Spa® will drain to the drain fitting in the footwell of the spa).
5. Remove filter cartridges and screen adaptors. Clean and store in a dry place.
6. Using a wet/dry shop vac vacuum, soak up the water remaining on the bottom of the spa.
7. Open unions at the heater and at the pump(s). Remove pump(s) from spa. Vacuum up water from return and suction sides of the plumbing on the pump(s). Vacuum any water from heater housing. Leave unions at the heater and at the pump(s) open.
8. Reverse vacuum and blow out each line of the plumbing going into the pump(s).

Important:

Do not use ethylene glycol based antifreeze. This type of antifreeze is toxic and can damage the spa surface.

9. With a shop vac, go to every jet in the spa (including suction fittings) and place vac hose over the face of every jet and vacuum out any water left in the lines. Reverse vac hose airflow and force air through each jet.
10. Wipe down spa shell with a soft clean cloth.
11. Place spa cover over spa and lock into place.
12. To restart the spa, connect all hoses and close all unions. Once all the hoses, jet valve assemblies, and pump unions are reattached, follow the normal fill-up procedures. It may be necessary to flush the spa depending on the amount of antifreeze used.

Note: It may be necessary to lubricate o-rings and gaskets for a positive seal. Use only Saratoga Spa® approved lubricants, contact your local dealer for more information.

Important:

If these instructions are not followed, damage due to freezing water in the plumbing lines may occur and is not covered under manufacturer's warranty.

WATER QUALITY MAINTENANCE

General Information

As the owner of a Saratoga Spa®, endless hours of entertainment, recreation, and relaxation await you. Caring for your spa will become a routine and pleasant part of your daily activities. You will be able to maintain your spa water and keep your spa equipment in excellent condition. To do so you first must balance your spa water.

Balanced Water

Balanced water ensures spa bathers safety as well as protecting the spa heater and components from corrosion. Also, balanced water protects the spa surface from unsightly scale deposits which reduce the efficiency of the spa equipment. You can obtain balanced water by correctly adjusting a few chemical components in the water. Specifically, you will need to adjust the pH, total alkalinity and calcium hardness

Note: Improper water chemistry can result in product failure and invalidate your warranty.

pH

pH is measured on a scale that runs from 0-14. pH indicates whether water is neutral, acidic, or basic. The drawing below shows a pH equal to 7.0 is neutral. A pH below this point is acidic and a pH above this point is basic.

Test pH weekly

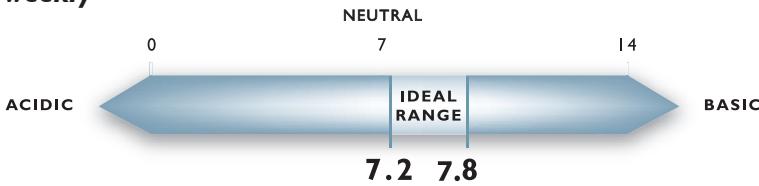

Recommended Range - 7.2 to 7.8

If the pH is too low it can

1. Corrode metal surfaces.
2. Use excess sanitizer.
3. Irritate bathers' skin and eyes.

If the pH is too high it can

1. Deposit scale on surfaces.
2. Contribute to cloudy water.
3. Cause eye irritation.
4. Reduce sanitizer efficiency.

Adjusting pH

To raise pH add a granular pH Increaser or sodium carbonate at the rate suggested on the container. To lower pH add a granular pH Decreaser, or sodium bisulfate at the rate suggested on the container. After initial application, allow water to circulate approximately 15 minutes on Pump 1 at high speed. Test pH and add second dose if required.

Total Alkalinity

There are minerals in your spa water that act as buffering agents. Total alkalinity is the measurement of these alkaline materials that help prevent corrosion and staining. The correct amount of alkalinity in your spa water will keep the water's pH consistent while allowing for economical pH adjustment when necessary.

Example: At low total alkalinity levels, the water's pH easily drifts, making frequent pH adjustments necessary and the added expense of multiple chemical treatments.

On the other hand, a high total alkalinity level keeps the water's pH rigidly fixed. If pH adjustment is necessary, you will need unusually large amounts of treatment chemicals to change the water's pH.

Recommended Range: 80 to 120 Parts Per Million (PPM)

Potential Problems:

1. pH difficult to maintain. If total alkalinity is too low, pH will drift.
2. Corrosive tendencies. If total alkalinity is too high:
 - pH difficult to adjust (it remains fixed.)
 - Cloudy water.
 - Potential for scaling.
 - High pH and low sanitizer efficiency.

Note: The use of Biguanide, Salt generators and other after market sanitizer/ disinfectant systems may damage components and void your spa's warranty.

TESTING WEEKLY

Adjusting Total Alkalinity

Total Alkalinity can be raised with Alkalinity Increaser, or sodium bicarbonate at the manufacturer's recommendation for dosage.

Calcium Hardness

Calcium hardness is the amount of dissolved calcium in your spa water. Too little calcium in the water will etch plaster surfaces, too much will leave deposits on surfaces and equipment.

Recommended Range: 125-150

Potential Problems:

Calcium Hardness Too Low:

- Some surfaces may be etched.
- May lead to equipment corrosion.

Calcium Hardness Too High:

- May contribute to cloudy water.
- Scaling of surface, piping and equipment.

Adjusting Calcium Hardness

Raise hardness by the addition of calcium chloride. Decrease calcium hardness by draining spa and replacing with water containing lower levels of calcium hardness.

Disinfectant

- Brominating Tablets, Granular Bromine and Granular Chlorine are popular disinfectants and are particularly well suited to compliment your ozone purification system spa. They are also very suitable products in water with elevated temperatures.
- Brominating Tablets and Granular Bromine are effective as a spa water sanitizer and disinfectant. Follow manufacturer's directions for proper dosage. It is recommended to maintain an active bromine residual of 2.0 to 4.0 ppm.
- Granular Chlorine (Dichlor Dihydrate, Lithium Hypochlorite), is designed to dissolve quickly and completely, provide a steady source of available chlorine to control the growth of algae, kill bacteria and destroy organic contaminants. It is recommended to maintain a chlorine residual of between 1.0 and 3.0 ppm.. Non-Chlorine type shock will oxidize or destroy most of the organic contaminants that result from bather load. This quick acting oxidizing shock treatment goes to work almost immediately improving water quality and eliminating irritating wastes and odor. This product is intended to be a shock treatment only, and is not a disinfectant.

Shock Treatment with Granular Disinfectant

Adding granular chlorine or bromine disinfectant to the water in amounts much larger than normal is called “shocking” the spa and should not be confused with non-chlorine shock. An occasional shock treatment destroys algae, bacteria, and chloramines. After shocking your spa, do not allow bathers to enter the spa until disinfectant levels drop to normal.

What Causes Loss of Disinfectant?

- **Algae:** The presence of algae will consume large amounts of disinfectant. If you have an algae problem, the use of an algacide in addition to disinfectant may be necessary.
- **Bather Load:** The greater the number of people using your spa, the more disinfectant you will need to use.
- **Improper pH:** A high pH above 7.8 substantially retards disinfecting. Keep the pH between 7.2 and 7.8.
- **Sunlight:** The sun’s Ultraviolet (UV) rays readily dissipate disinfectant levels.
- **Water Temperature:** High water temperature accelerates the loss of disinfectant.
- **Weather:** Rain and wind can carry a significant amount of contaminants into your spa.

Remember to Maintain:

- pH 7.2 to 7.8
- Total alkalinity 80 to 120 ppm
- If using brominating tablets the proper level in dispenser
- Maintain granular chlorine residual level at 1.0 to 3.0 ppm
- Maintain bromine residual level at 2.0 to 4.0
- Calcium hardness 125-150
- Non-chlorine shock weekly or as needed based on spa use
- Test pH, total alkalinity and calcium hardness weekly
- Test disinfectant daily (Spa test kits are available through your Saratoga Spa® Dealer.)

Ozone Generators

The Saratoga Spa® Luxury Line comes equipped with an ozone generator. It automatically produces ozone 24 hours a day through our Whisper Clean® System, unless it is overridden by another system protection mode. (For ozone trouble shooting see page 54) The Ozone generator is a wearable item that will need to be replaced approximately every two years. This is a non-warranty item.

What is Ozone?

Ozone is nature’s natural purifier. It is a chemical known as O₃ and is produced from simple oxygen molecules in our atmosphere. Ozone will breakdown and oxidize oils, greases, suntan lotions, sweat, urea, etc. from spa water more effectively than any other oxidizer commercially available. Ozone also assists chlorine, or bromine, to destroy bacteria and viruses and will do so more effectively. Ozone only leaves simple oxygen in the water as a by-product.

How is Ozone Produced?

Ozone is produced in nature from lightning during electrical storms and is also produced from ultraviolet rays from the sun to form our protective ozone layer. Your ozone converter unit is designed to duplicate this natural sanitizer.



Always follow instructions and dosages listed by chemical manufacturers. Use only spa chemicals in your spa. Do not mix chemicals or add chemicals during bather use.

OPERATIONS TROUBLE SHOOTING GUIDE

PROBLEM	PROBABLE CAUSE	SOLUTIONS
Spa is not operating	<ul style="list-style-type: none"> • Power failure • RCD breaker tripped 	<ul style="list-style-type: none"> • Check power source • Try resetting RCD breaker. If breaker continues to trip, contact your dealer.
	<ul style="list-style-type: none"> • Dirty filters • Temperature setting too low 	<ul style="list-style-type: none"> • Clean the filters • Increase the set temperature
Spa is not heating	<ul style="list-style-type: none"> • Air trapped in circulation line 	<ul style="list-style-type: none"> • Using a garden hose, force water through Whisper Clean® cartridge opening or loosen the bottom heater union to allow trapped air to escape.
	<ul style="list-style-type: none"> • Spa could be in Economy (ECN) or sleep (SLP) mode 	<ul style="list-style-type: none"> • Press the TEMP then JETS button to adjust Heat Modes. FC is continuous and operates the same as the Standard Mode Setting.
Poor or no water flowing through the jets	<ul style="list-style-type: none"> • Dirty filters • Inadequate water level 	<ul style="list-style-type: none"> • Clean the filters • Fill spa to 2" (5.08cm) above filters
	<ul style="list-style-type: none"> • Air lock • Closed Valve • Closed Jets 	<ul style="list-style-type: none"> • Prime the pump(s) by loosening unions on the pump(s) until air can be heard escaping, then tighten unions. • Check diverter valves and jets are open
Spa light out	<ul style="list-style-type: none"> • Burned out Color Blast™ Light 	<ul style="list-style-type: none"> • Replace with new Color Blast™ Light
	<ul style="list-style-type: none"> • Light not turned on 	<ul style="list-style-type: none"> • Press the light key to desired style and performance
Pump(s) turn off unexpectedly	<ul style="list-style-type: none"> • Automatic 15 minute shut off 	<ul style="list-style-type: none"> • Press jets button again to start another 15 minute cycle
	<ul style="list-style-type: none"> • Pump(s) may have overheated. Built in protective overheat shut off 	<ul style="list-style-type: none"> • Let pump sit for about 10-15 minutes. Allow pump to cool down, keep vented areas on access panel free from blockage.

OPERATIONS TROUBLE SHOOTING GUIDE

PROBLEM	PROBABLE CAUSE	SOLUTIONS
Spa jets/ pump(s) turn on automatically	• Normal purge filtration cycle	• No action necessary
	• "Ice Mode"	• No action necessary
Not able to operate main control panel	• Panel may have malfunctioned	• Contact your dealer
Water does not clear up	• Bad water chemistry	• Balance water
	• Dirty filter cartridges	• Clean or replace filters
	• Ozone generator not operating	• Locate ozone generator; a purple ultraviolet light to be illuminated in the ozone generator
	• Bromine/chlorine residual levels too low	• Adjust Bromine/chlorine levels. Shock if necessary. May have to replace water

DIAGNOSTIC DISPLAY MESSAGES ON MAIN CONTROL PANEL

Message	Meaning	Action Required
	No message on display. Power has been cut off to the spa.	The control panel will be disabled until power returns. Spa settings will be preserved until next power up.
--	Temperature unknown.	After the pump has been running for 2 minutes, the temperature will be displayed.
OHH	"Overheat." The spa has shut down. One of the sensors has detected 118°F/48°C at the heater.	DO NOT ENTER THE WATER. Remove the spa cover and allow water to cool. Once the heater has cooled, reset by pushing any button. If spa does not reset, shut off the power to the spa and call your dealer or service organization.
OHS	"Overheat." The spa has shut down. One of the sensors has detected that the spa water is 110°F/43°C.	DO NOT ENTER THE WATER. Remove the spa cover and allow water to cool. At 107°F/42°C, the spa should automatically reset. If spa does not reset, shut off the power to the spa and call your dealer or service organization.
ICE	"Ice." Potential freeze condition detected.	No action required. The pump and blower will automatically activate regardless of spa status.
SnA	Spa is shut down. The sensor that is plugged into the Sensor "A" jack is not working.	If the problem persists, contact your dealer or service organization. (May appear temporarily in an overheat situation and disappear when the heater cools.)
Snb	Spa is shut down. The sensor that is plugged into the Sensor "B" jack is not working.	If the problem persists, contact your dealer or service organization. (May appear temporarily in an overheat situation and disappear when the heater cools.)
SnS	Sensors are out of balance. If alternating with spa temperature, it may just be a temporary condition. If flashing by itself, spa is shut down.	If the problem persists, contact your dealer or service organization.
HFL	A significant difference between temperature sensors has been detected. This could indicate a flow problem.	Check water level in spa. Refill if necessary. If the water level is okay, make sure the pumps have been primed. If problem persists, contact your dealer or service organization.
LF	Persistent low flow problems. (Displays on the fifth occurrence of "HFL" message within 24 hours.) Heater is shut down, but other spa functions continue to run normally.	Follow action required for "HFL" message. Heating capability of the spa will not reset automatically; you may press any button to reset.
dr	Possible inadequate water level, poor flow, or air bubbles are detected in the heater. Spa is shut down for 15 minutes.	Check water level in spa. Refill if necessary. If water level is okay, make sure the pumps have been primed. Press any button to reset, or this message will automatically reset within 15 minutes. If problem persists, contact your dealer or service organization.
drY	Inadequate water level detected in heater. (Displays on third occurrence of "dr" message.) Spa is shut down.	Follow action required for "dr" message. Spa will not automatically reset. Press any button to reset.

Note: "dr" reading see page 21.

FLOW RELATED CHECKS -

Check for low water level, suction flow restrictions, ensure filters are clean, closed valves, trapped air, too many closed jets and pump prime.

On some systems even when the spa is shut down, some equipment may occasionally turn on to continue monitoring temperature or if freeze protection is needed.

All messages may not appear on your panel display.

DELIVERY AND MOVING INSTRUCTIONS

Important: Read these instructions before removing your Saratoga Spa® from its pallet. Refer to these instructions whenever moving your Saratoga Spa®.

When removing your Saratoga Spa® from its pallet or moving it on its side, please follow these instructions.

1. Standing at the ventilated equipment panel looking into the spa is the front orientation.

2. The side to the **RIGHT** is this orientation is the your moving side on the all Saratoga models.

3. When removed from the pallet, the spa must be **RIGHT SIDE DOWN** for all the moving and deliveries.

4. The **RIGHT** spa side is a reinforced for moving however, a cart must be used that will accommodate the width of the spa when in the upright position. When using a cart narrower than the spa, a wooden panel should be used between the spa and the cart to distribute the weight of the spa evenly. The **RIGHT SIDE PANEL** is not designed to support the entire weight of the spa.

5. Moving the spa on the Left, Rear, or Front equipment panel will void the wood skirt warranty.

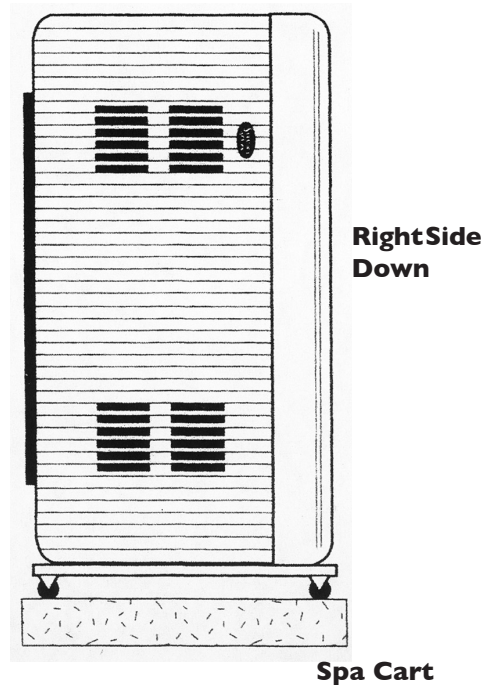
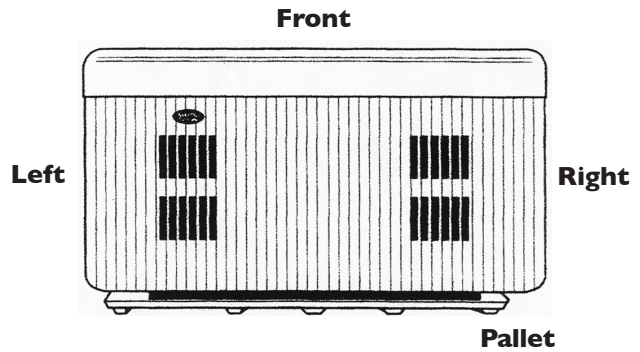

SERVICE AND WARRANTY INFORMATION

General Service Information

Your Saratoga Spa® has been designed to provide years of trouble-free use. As with any appliance, problems may occasionally occur that require the expertise of a qualified service person. Though such simple repairs as resetting a RCD switch or breaker, resetting a high limit thermostat or replacing a light bulb may not require a service call, they may indicate that a more serious condition exists. These conditions may require an experienced service person. Before calling for service, please refer to the Troubleshooting Guide.

Note: Always retain your original sales receipt for future reference.

Acts Invalidating Warranty

The limited warranty is void if the Saratoga Spa® has been improperly installed, subjected to alteration, misuse, or abuse, or if any repairs on the spa are attempted by anyone other than an authorized representative of Saratoga Spa® Company. Alteration shall include any component or plumbing change, electrical conversion, or the addition of any non-approved sanitation or water purification device, or heating system which contributes to component or unit failure or unsafe operating system. Misuse and abuse shall include any operation of the spa other than in accordance with Saratoga Spa® Company printed instructions, or use of the spa in an application for which it is not designed; specifically: use of the spa in a non-residential application; damage caused by operation* of the spa at water temperatures outside the range of 2°C and 49°C; damage caused by a dirty, clogged or calcified filter cartridge; damage to the spa components or spa surface determined to have been caused by improper water maintenance or improper use of chemicals (refer to pages 50-52 of this owners manual); damage caused by allowing undissolved spa sanitizing chemicals to lie on the spa surface (no spa surface material can withstand this kind of abuse); and damage to the spa surface caused by leaving the spa uncovered while empty of water and in direct exposure to sunlight (this may cause solar heating distress in warm weather regions). These are considered abuses and may invalidate this warranty.

Acts of nature, and damage caused by animals, rodents, and insects are considered abuses and are not covered under this warranty.

*Operation of the spa does not mean “use” of the spa! Saratoga Spa® Company does not recommend using the spa if the water temperature is above or below the spa’s control panel temperature range.

DISCLAIMERS

Saratoga Spa® Company shall not be liable for loss of use of the Saratoga Spa® or other incidental, consequential, special, indirect, or punitive costs, expenses or damages, which may include but are not limited to the removal of a permanent deck or other custom fixture or the necessity for crane removal. Any implied warranty shall have a duration equal to the duration of the applicable limited warranty stated above. Some states do not allow limitations on how long an implied warranty lasts. Under no circumstances shall Saratoga Spa® Company or any of its representatives be held liable for injury to any person or damage to any property, however arising.

Some states do not allow the exclusion or limitation of incidental or consequential damages, so the above limitations may not apply to you.

SPA CARE AND MAINTENANCE RECORD

DATE	<i>Drain and Clean Spa Shell</i>	<i>Spray Clean Filter Cartridge</i>	<i>Soak Filter Cartridge</i>	<i>Complete Spa Water Balance</i>	<i>Clean and Condition Vinyl Spa Cover</i>	<i>Winterize Spa</i>	<i>Miscellaneous Service</i>

SPA CARE AND MAINTENANCE RECORD

DATE	<i>Drain and Clean Spa Shell</i>	<i>Spray Clean Filter Cartridge</i>	<i>Soak Filter Cartridge</i>	<i>Complete Spa Water Balance</i>	<i>Clean and Condition Vinyl Spa Cover</i>	<i>Winterize Spa</i>	<i>Miscellaneous Service</i>

SPA CARE AND MAINTENANCE RECORD

<i>DATE</i>	<i>Drain and Clean Spa Shell</i>	<i>Spray Clean Filter Cartridge</i>	<i>Soak Filter Cartridge</i>	<i>Complete Spa Water Balance</i>	<i>Clean and Condition Vinyl Spa Cover</i>	<i>Winterize Spa</i>	<i>Miscellaneous Service</i>



33 Wade Road
Latham, NY 12110
1-800-444-9977
fax: 518-782-0632
www.SaratogaSpas.com

25013IE-7/14