

Saratoga Spa[®]

OWNER'S MANUAL

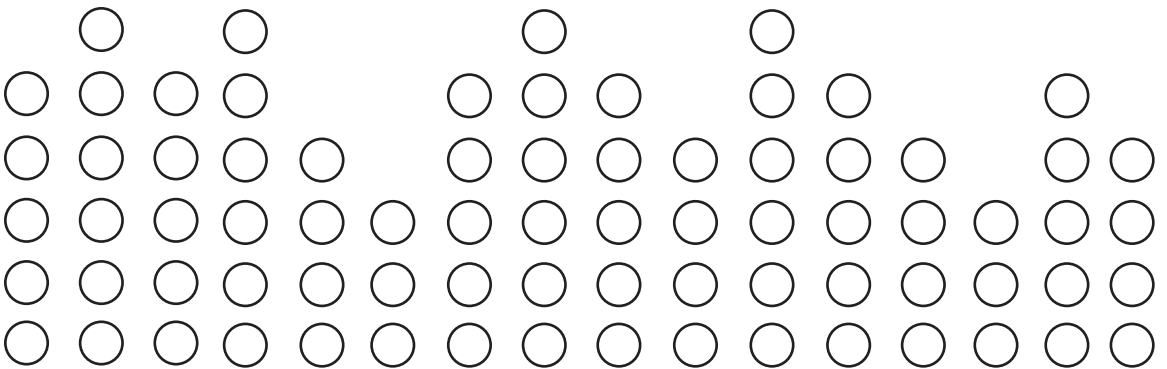

Luxury and Select Plus Edition



Model: _____
 Serial Number: _____
 Date Installed: _____
 Dealer: _____
 Address: _____
 Telephone: _____

Note: The serial number/identification label is located within the equipment compartment and skimmer housing.

Model	Average Fill Gallons	Average Filled lbs.	Average Dry lbs.
LUXURY SERIES			
#5000 - Polo	150	1753	500
#6000 - Adelphi	240	2504	500
#4000 - Putnam	340	3457	620
#2000 - Excelsior	310	3369	780
#1000 - Canfield	375	3880	750
#4000 - Regent	425	4297	750
#8000 - Lincoln	525	5302	920
#9000 - Empire	525	5302	920
#11000 - Broadway	795	7835	1200
SELECT PLUS SERIES			
#300 - Lexington* Plus	350	3622	700
#1000 - Clifton* Plus	375	3832	700
#900 - Franklin* Plus	525	5203	820

Thank you for your recent Saratoga Spa Purchase.

This owners manual has been designed to acquaint you with your Saratoga Spa's operation and general maintenance.

Keep this manual available for future reference.

If you have any questions regarding your Saratoga Spa, contact your local dealer.

Thank you.

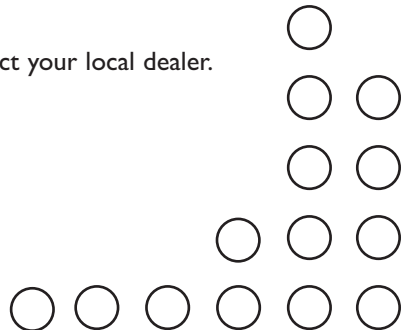
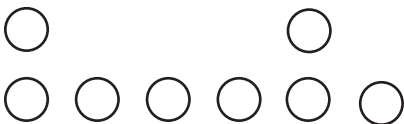



Table of Contents

SARATOGA SPA SAFETY INSTRUCTIONS

Avoiding Risk to Children	2
Avoiding Risk of Electrical Shock	3
Avoiding Risk of Injury	3
Unclean Water	4
Avoiding Risk of Hyperthermia	4
Avoiding Risk of Skin Burns	5
Important Spa Instructions	5

LUXURY AND SELECT LINE SPA MODELS

Specifications	6
----------------------	---

LUXURY LINE FEATURES AND OPERATIONS

Polo	7
Adelphi	8
Putnam	9
Excelsior	10
Canfield	11
Regent	12
Lincoln	13
Empire	14
Broadway	15

SELECT LINE FEATURES AND OPERATIONS

Lexington Plus	16
Clifton Plus	17
Franklin Plus	18

INSTALLATION INSTRUCTIONS

Location Preparation	19
Outdoor Installation	19
Indoor Installation	19

ELECTRICAL REQUIREMENTS AND PRECAUTIONS

220 Volt Permanently Connect Models	20
<i>Electrical Installation Instructions</i>	
220 Volt Models	20-21
<i>Electrical Spa Wiring Connection Instructions</i>	
220 Volt Models	21
110/220 Volt Convertible Models	22
<i>Electrical Installation Instructions</i>	
110 Volt Models	22
<i>Electrical Spa Wiring Connection Instructions</i>	
110 Volt Models	22-23

INITIAL OPERATING INSTRUCTIONS

Start-up and Re-fill Procedures	24
Start-up Procedures	25-26
Saratoga Spa Jet Identifications	27-28
Saratoga Spa Jet Selectors	29

JET SYSTEM MENUS

Jet Therapy Zones	30
Polo	31
Adelphi	32
Putnam	33
Excelsior	34
Canfield	35
Regent	36-37
Lincoln	38-39
Empire	40-41
Broadway	42-43
Lexington Plus	44
Clifton Plus	45
Franklin Plus	46

EQUIPMENT MAINTENANCE

Jet Selector Maintenance	47
Moto Stream™ Valve Maintenance	47-48
Light Bulb Replacement	48

CONTROL PANEL OPERATION

Main Panel	49
Temperature Control	49
Conserve Mode	49
Jet Buttons	50
Option Button	50
Light Control Button	51
Optional Color Blast and Color Splash Lighting	51
Main Control Panel Locking Features	51
Major Spa Panel Lock	51
Minor Temperature Lock	51

SPA CARE AND WATER MAINTENANCE

General Information	52
Filter Cartridge Removal and Cleaning	53
Care of Pillows	53-54
Care of Exterior	54
Care of Spa Cover	54-55
Winterizing Your Spa	55-56
Water Quality Maintenance	57-59

TROUBLESHOOTING

Troubleshooting Guides	60-61
Smart Winter Mode	61
Summer Setting Mode	61-62
Diagnostic Display Messages	61-62

PARTS AND WARRANTY INFORMATION

Service and Warranty Information	63-64
Replacement Parts	65
Accessories	65-66
Spa Care and Maintenance Record	67-68

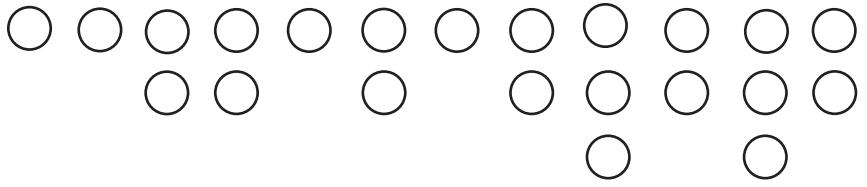

**READ AND FOLLOW ALL INSTRUCTIONS
AVOIDING THE RISK TO CHILDREN**
Spa Safety reminders

DANGER:

Risk of Child Drowning

Extreme caution must be exercised to prevent unauthorized access by children. To avoid accidents, ensure that children cannot use a spa unless they are supervised at all times.

WARNING:

- *To reduce the risk of injury, do not permit children to use this spa unless they are closely supervised at all times.*
- *To reduce the risk of injury, lower water temperatures are recommended for young children. Children are especially sensitive to hot water.*

DO:

- Make sure you always lock the child resistant spa cover locks after using the spa for your children's safety. Every Saratoga Spa is equipped with a locking cover that meets the ASTM F1346-91 Standard for Safety Covers.
- Test the water temperature with your hand before allowing children to enter the spa to be sure that it's comfortable. Children are especially sensitive to hot water.
- Remind children that wet surfaces can be very slippery. Make sure that children are careful when entering or exiting the spa.

DON'T:

- Allow children to climb onto the spa cover.
- Allow children to have unsupervised access to the spa.

DANGER:

Risk of Child Electrocutation

- Connect only to a grounded source.
- Do not bury the power cord. A buried power cord may result in death, or serious personal injury due to electrocution if direct burial-type cable is not used, or if improper digging occurs.
- A ground terminal (pressure wire connector) is provided on the control box inside the unit to permit connection of a minimum No. 8 AWG (8.4 mm) solid copper bonding conductor between this point and any metal equipment, metal water pipe, metal enclosures of electrical equipment, or conduit within five feet (1.5 m) of the unit as needed to comply with local requirements.
- To reduce the risk of electrocution, replace all damaged cords immediately. Failure to do so may result in death or serious personal injury due to electrocution.

DANGER:

Risk of Electric Shock

- Do not permit any electrical appliance, such as a light, telephone, radio or television within 5 feet (1.5m) of a spa. These units DO NOT have an internal ground fault circuit interrupter. The installation of a ground fault circuit interrupter MUST be done by a qualified Electrician and must meet all local and national codes. Failure to maintain a safe distance may result in death, or serious personal injury due to electrocution, if the appliance should fall into the spa.
- Install at least 5 feet (1.5 m) from all metal surfaces. A spa may be installed within 5 feet of a metal surface if each metal surface is permanently connected by a minimum No. 8 AWG (8.4 mm) solid copper conductor attached to the wire ground connector on the terminal box that is provided for this purpose if in accordance with National Electrical Code ANSI/NMFA70-1993.
- Install your spa in such a way that drainage is away from the electrical compartment and from all electrical components.

DO:

- Do test the water temperature with your hand before entering the spa to be sure the water temperature is comfortable.
- Do keep the spa cover locked when the spa is not in use.
- Do check the equipment compartment monthly for any signs of tampering to the spa equipment.
- Do follow the maintenance instructions of the spa found in this owner's manual.
- Be sure your spa is connected to the power supply correctly - use a licensed electrical contractor.
- Test the Ground Fault Circuit Interrupter(s) once a month.

DON'T:

- Use the spa with the equipment compartment door removed.
- Place electrical appliances within 5 feet (1.5m) of the spa.
- Don't allow children to have unsupervised access to the spa.
- Don't block the equipment compartment vents. This could cause damage to the spa equipment and will void the warranty.

DANGER:

Risk of Personal Injury

- To reduce the risk of injury to persons, DO NOT remove suction fittings located at the bottom footwells of the spa.
- The suction fittings in the spa are sized to match the specific water flow created by the pump. Never replace a suction fitting with one rated less than the flow rate marked on the original suction fitting. Never operate the spa if the suction fittings are broken or missing.
- There is a danger of slipping and falling. Remember that wet surfaces can be very slippery. Take care when entering or exiting the spa.
- People with infectious diseases should not use the spa.
- Keep any loose articles of clothing or hanging jewelry away from rotating jets or other moving components.
- The use of drugs, alcohol, or medication before or during spa use may lead to unconsciousness with the possibility of drowning.
- Persons using medications should consult a physician before using a spa; some medication may cause a user to become drowsy, while other medication may affect heart rate, blood pressure, and circulation.

- Persons taking medications which induce drowsiness, such as tranquilizers, antihistamines or anticoagulants should not use the spa.
- Water temperature in excess of 38°C (100.4°F) may be injurious to your health.
- Pregnant women should consult a physician before using spa.
- Persons suffering from obesity, or with a medical history of heart disease, low or high blood pressure, circulatory system problems, or diabetes should consult a physician before using spa.

Unclean water

- Keep the water clean and sanitized with correct chemical care.
- Maintain water chemistry in accordance with chemical manufacturer's instructions.

Important:

- **Turn on Jet Pump #1, on high speed, for a 15 minute cycle (or 20 minutes for Polo Adelphi, and Putnam) after adding ANY spa water chemicals into the spa.**
- **Clean the filter cartridges monthly to remove debris and mineral buildup which may affect the performance of the jets, limit the flow, or trip the high limit thermostat.**

DANGER:

Risk of Hyperthermia

The causes, symptoms and effects of hyperthermia may be described as follows: Hyperthermia occurs when the internal temperature of the body reaches a level several degrees above the normal body temperature of 98.6°F. The symptoms of hyperthermia include an increase in the internal temperature of the body, dizziness, lethargy, drowsiness and fainting.

The effects of hyperthermia include:

1. Failure to perceive heat.
2. Failure to recognize the need to exit the spa or hot tub.
3. Unawareness of impending hazard.
4. Fetal damage in pregnant women.
5. Physical inability to exit the spa or hot tub.
6. Unconsciousness resulting in drowning.

WARNING:

The use of alcohol, drugs, or medication can greatly increase the risk of fatal hyperthermia in hot tubs and spas.

To Reduce the Risk of Injury:

- The water in the spa should never exceed 104°F (40°C). Water temperatures between 100°F (37.7°C) and 104°F (40°C) are considered safe for a healthy adult.
- Lower water temperatures are recommended for extended use (exceeding ten minutes) and for young children. Extended use can cause hyperthermia.
- Pregnant or possibly pregnant women should limit spa water temperatures to 100°F. Failure to do so may result in permanent injury to your baby.
- Do not use spa immediately following strenuous exercise.

DANGER:

Avoiding the Risk of Skin Burns

- To reduce the risk of injury, before entering a spa the user should measure the water temperature with an accurate thermometer; since the tolerance of temperature-regulating devices may vary by as much as $\pm 5^{\circ}\text{F}$.
- Test the water with your hand before entering the spa to be sure it's comfortable.

Important:

The following contains important spa information, and we strongly encourage you to read and apply them.

DO:

- Use and lock the vinyl cover when the spa is not in use, whether it is empty or full.
- Follow the Spa Care and Maintenance recommendations stated in this manual.
- Use only approved accessories and recommended spa chemicals and cleaners.

DON'T:

- Leave the Saratoga spa exposed to the sun without water or the cover in place. Exposure to direct sunlight can cause solar distress of the shell material.
- Lift or drag the vinyl cover by using the cover lock straps; always lift or carry the cover by using the handles.
- Attempt to open the electrical control box. There are no user serviceable parts inside. Opening of the control box by the spa owner will void the warranty. If you have an operational problem, carefully go through the steps outlined in the Troubleshooting section. If you are not able to resolve the problem, contact your authorized Saratoga Spa dealer. Many problems can easily be diagnosed over the telephone by an Authorized Service Technician.
- Block or sit on the filter compartment area.
- Allow excessive weight to be placed on the spa cover. Doing so could damage the spa cover and void any warranty.

*** SAVE THESE INSTRUCTIONS ***

Luxury Line Spa Specifications

	Width	Height	Length	Average Fill	Dry Weight	Average Fill Weight	Seating Locations
Polo	57" 1.45 m	29" 0.74 m	80" 2.03 m	150 gal 568 L	500 lbs. 227 kg	1,753 lbs. 795 kg	2 2
Adelphi	67" 1.70 m	29" 0.74 m	80" 2.03 m	240 gal 909 L	500 lbs. 227 kg	2,504 lbs. 1,136 kg	3-4 3-4
Putnam	75" 1.91 m	34" 0.86 m	84" 2.13 m	340 gal 1,287 L	620 lbs. 281 kg	3,457 lbs. 1,568 kg	4-6 4-6
Excelsior	84" 2.13 m	36" 0.91 m	84" 2.13 m	310 gal 1,174 L	780 lbs. 354 kg	3,369 lbs. 1,528 kg	4-5 4-5
Canfield	84" 2.13m	36" 0.91m	84" 2.13m	375 gal 1,420 L	750 lbs. 340 kg	3,880 lbs. 1,760 kg	5-6 5-6
Regent	84" 2.13 m	36" 0.91 m	90" 2.29 m	425 gal 1609 L	750 lbs. 340 kg	4,297 lbs. 1,949 kg	5-6 5-6
Lincoln	89" 2.26 m	38" 0.97 m	93" 2.36 m	525 gal 1988 L	920 lbs. 417 kg	5,302 lbs. 2,405 kg	6-7 6-7
Empire	89" 2.26 m	38" 0.97 m	93" 2.36 m	525 gal 1988 L	920 lbs. 417 kg	5,302 lbs. 2,405 kg	6-8 6-8
Broadway	92" 2.34 m	40" 1.02 m	108" 2.74 m	795 gal 3010 L	1200 lbs. 544 kg	7,835 lbs. 3,554 kg	9 9

Select Plus Series Specifications

	Width	Height	Length	Average Fill	Dry Weight	Average Fill Weight	Seating Locations
Lexington Plus	80" 2.03 m	34" 0.86 m	84" 2.13 m	350 gal 1325 L	700 lbs. 318 kg	3336 lbs. 1513 kg	5 5
Clifton Plus	84" 2.13 m	36" 0.91 m	84" 2.13 m	375 gal 1420 L	700 lbs. 318 kg	3630 lbs. 1647 kg	6-7 6-7
Franklin Plus	89" 2.26 m	38" 0.97 m	93" 2.36 m	525 gal 1988 L	820 lbs. 372 kg	5084 lbs. 2306 kg	6-7 6-7

Important:

Saratoga Spa Company suggests a structural engineer or contractor be consulted before the spa is placed on an elevated deck.

Note: The "Average Full" weight of the spa includes only the spa and the water inside the spa.

Polo 110V/220V SPA FEATURES

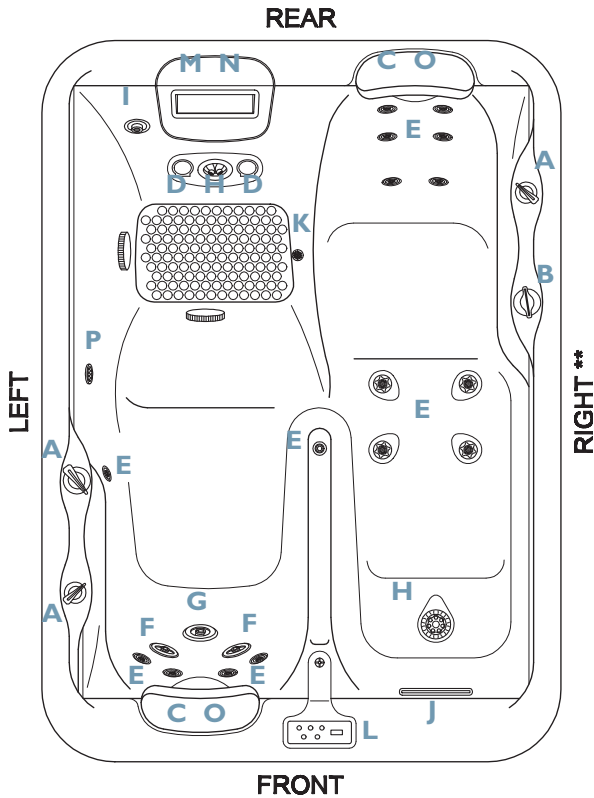

- A. Versa-Flo™ Valve/
Versa-Flo™ Micro Valves
- B. Roto Stream™ Valve
- C. Power Massage® Jets
- D. Power Stream® Jets
- E. Cluster Jets
- F. Mini Jets
- G. Deluxe Jet
- H. Storm Jets
- I. Vortex Jet™ Circulation
- J. Relax Stream™ Waterfall
- K. Footwell Spa Drain
- L. Backlit Digital Control Panel
- M. Microban® Filtration
- N. Toploading Skimmer
- O. Pillows
- P. Mood Light

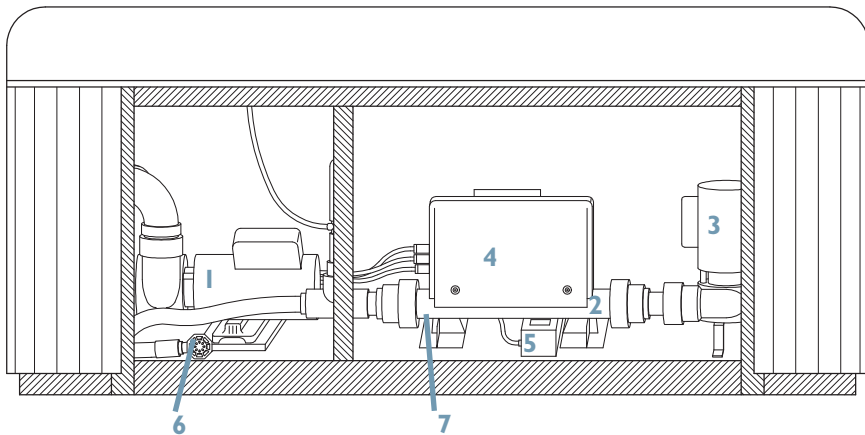

Polo 110V/220V SARATOGA SPA OPERATIONS CENTER

1. 1 Uni Speed Hydro Pump or *Optional Factory Installed 220V 3.6Hp Pump, 1 speed
2. 1 kW/4 kW Heater
3. Purity Circulation™ Pump
4. 110V/220V Power Pak
5. Whisper Zone™ Ozonator
6. Drain Valve
7. Bonding Terminal

Adelphi 110V/220V SPA FEATURES

- A. Versa-Flo™ Valve/
Versa-Flo™ Micro Valves
- B. Roto Stream™ Valve
- C. Power Massage® Jets
- D. Power Stream® Jets
- E. Cluster Jets
- F. Mini Jets
- G. Deluxe Jets
- H. Vortex Jet™ Circulation
- I. Footwell Spa Drain
- J. Relax Stream™ Waterfall
- K. Backlit Digital Control Panel
- L. Microban® Filtration
- M. Toploading Skimmer
- N. Pillows
- O. Storm Jet
- P. Mood Light

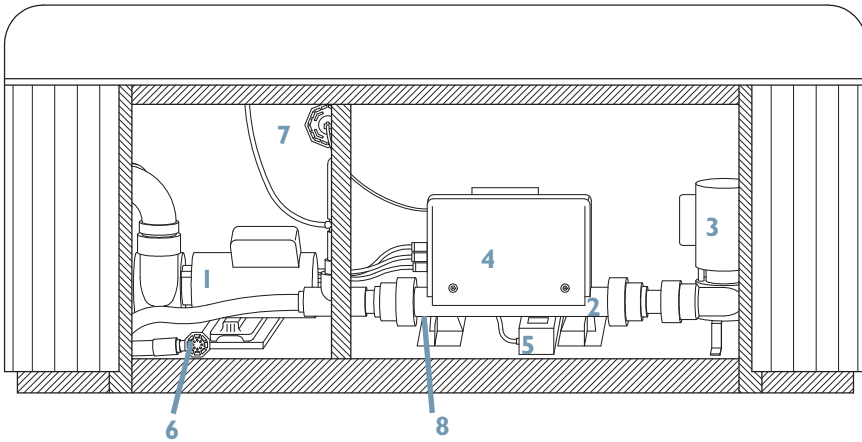
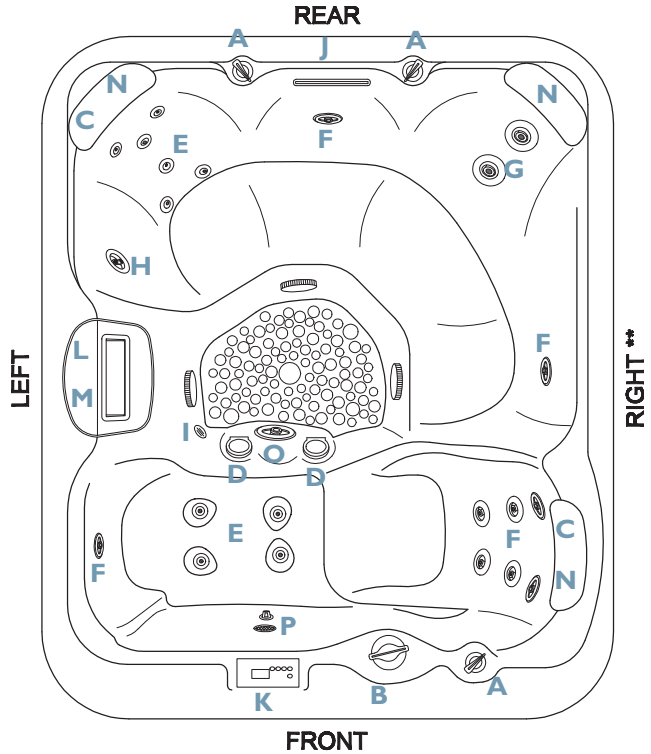

Adelphi 110V/220V SARATOGA SPA OPERATIONS CENTER

- 1. 1 Uni Speed Hydro Pump or *Optional Factory Installed 220V 3.6Hp Pump, 1 speed
- 2. 1 kW/4 kW Heater
- 3. Purity Circulation™ Pump
- 4. 110V/220V Power Pak
- 5. Whisper Zone™ Ozonator
- 6. Drain Valve
- 7. Mood Light
- 8. Bonding Terminal

Putnam 110V/220V SPA FEATURES

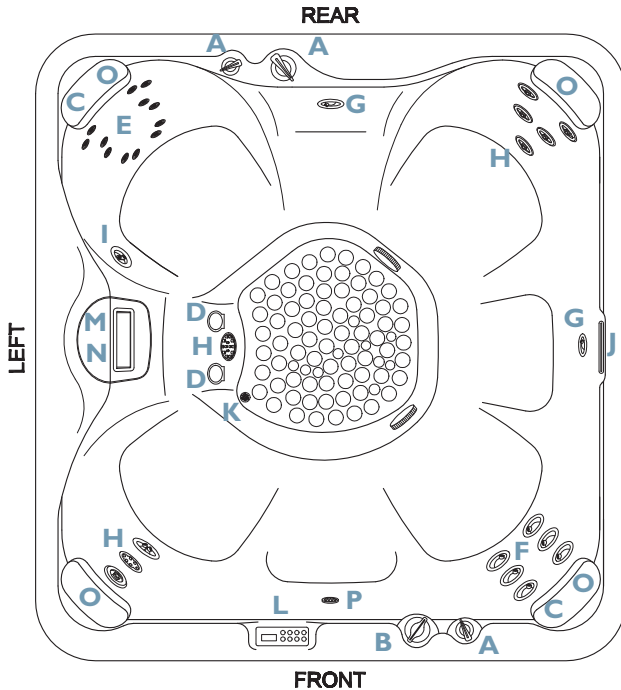

- A. Versa-Flo™ Valve/
Versa-Flo™ Micro Valves
- B. Roto-Stream™ Valve
- C. Power Massage® Jets
- D. Power Stream® Jets
- E. Cluster Jets
- F. Mini Jets
- G. Deluxe Jets
- H. Storm Jets
- I. Vortex Jet™ Circulation
- J. Relax Stream™ Waterfall
- K. Footwell Spa Drain
- L. Backlit Digital Control Panel
- M. Microban® Filtration
- N. Toploading Skimmer
- O. Pillows
- P. Mood Light

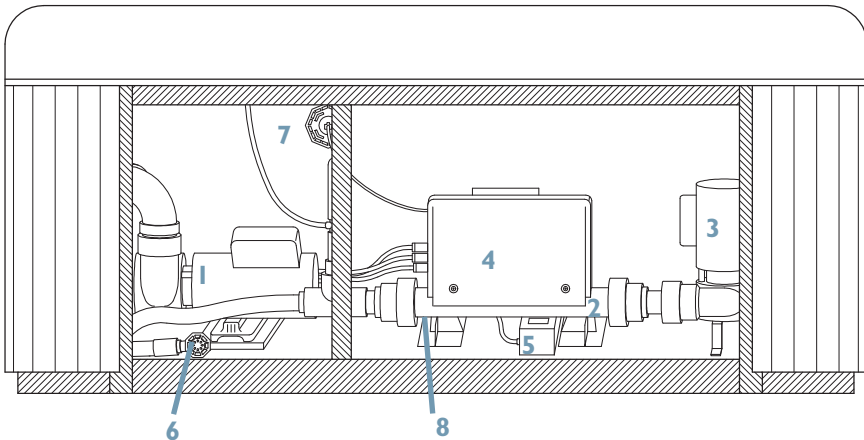

Putnam 110V/220V SARATOGA SPA OPERATIONS CENTER

- 1. 1 Uni Speed Hydro Pump or *Optional Factory Installed 220V 3.6Hp Pump, 1 speed
- 2. 1 kW/4 kW Heater
- 3. Purity Circulation™ Pump
- 4. 110V/220V Power Pak
- 5. Whisper Zone™ Ozonator
- 6. Drain Valve
- 7. Mood Light
- 8. Bonding Terminal

Excelsior SPA FEATURES

- A. Versa-Flo™ Valves/
Versa-Flo™ Micro Valves
- B. Roto Stream™ Valve
- C. Power Massage® Jets
- D. Power Stream® Jets
- E. Cluster Jets
- F. Mini Jets
- G. Deluxe Jets
- H. Storm Jets
- I. Vortex Jet™ Circulation
- J. Footwell Spa Drain
- K. Relax Stream™ Waterfall
- L. Backlit Digital Control Panel
- M. Microban® Filtration
- N. Toploading Skimmer
- O. Pillows
- P. Mood Light

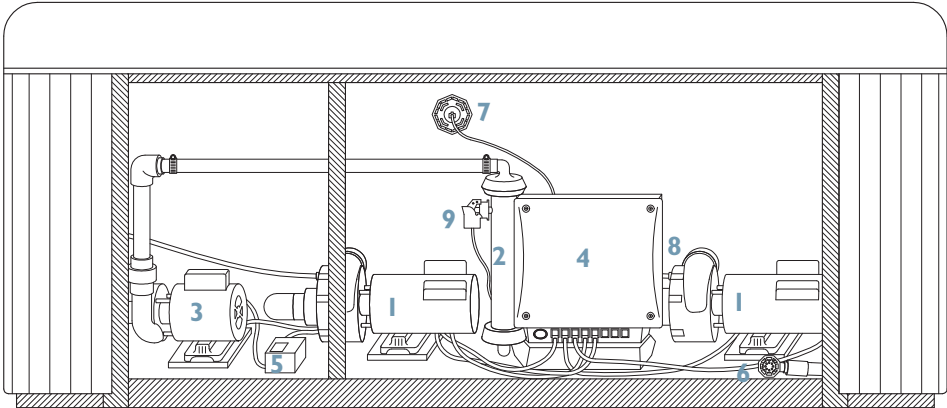
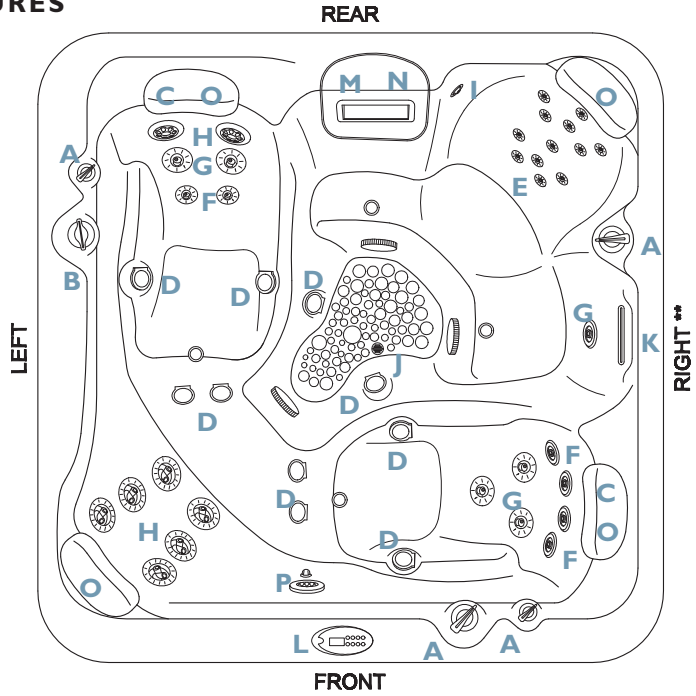

Excelsior SARATOGA SPA OPERATIONS CENTER

- 1. (2) Dual Speed Hydro Pumps
- 2. 4 kW Heater
- 3. Purity Circulation™ Pump
- 4. 220V Power Pak
- 5. Whisper Zone™ Ozonator
- 6. Drain Valve
- 7. Mood Light
- 8. Bonding Terminal
- 9. Pressure Switch

Canfield SPA FEATURES

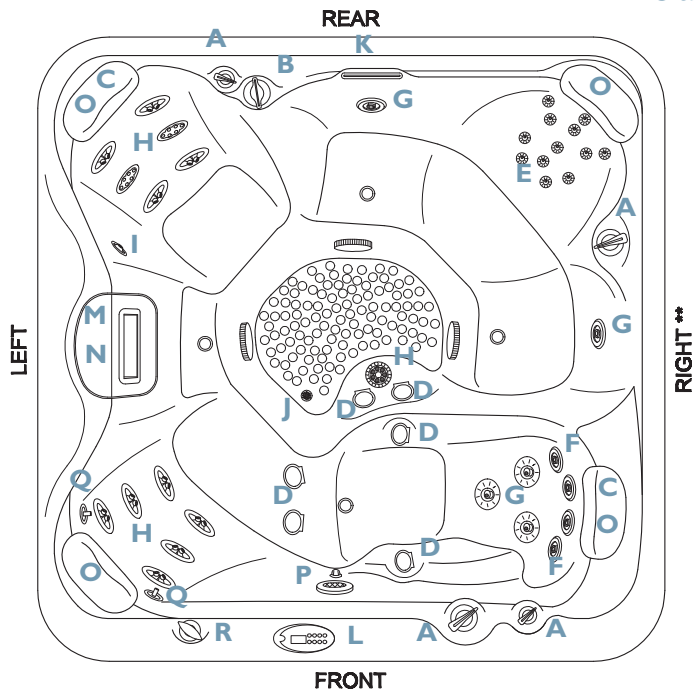

- A. Versa-Flo™ Valves/
Versa-Flo™ Micro Valves
- B. Roto Stream™ Valve
- C. Power Massage® Jets
- D. Power Stream® Jets
- E. Cluster Jets
- F. Mini Jets
- G. Deluxe Jets
- H. Storm Jets
- I. Vortex Jet™ Circulation
- J. Footwell Spa Drain
- K. Relax Stream™ Waterfall
- L. Backlit Digital Control Panel
- M. Microban® Filtration
- N. Toploading Skimmer
- O. Pillows
- P. Mood Light
- Q. Projet Stream™
- R. Projet Stream™ Valve

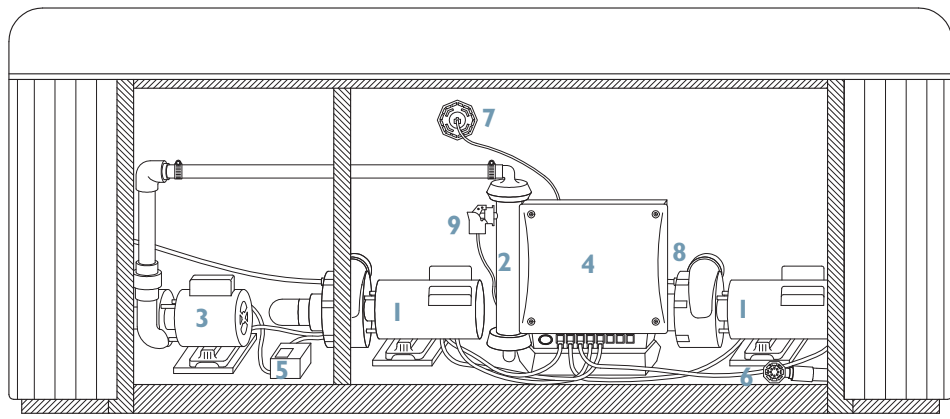

Canfield SARATOGA SPA OPERATIONS CENTER

- 1. (2) Dual Speed Hydro Pumps
- 2. 4 kW Heater
- 3. Purity Circulation™ Pump
- 4. 220V Power Pak
- 5. Whisper Zone™ Ozonator
- 6. Drain Valve
- 7. Mood Light
- 8. Bonding Terminal
- 9. Pressure Switch

Regent SPA FEATURES

- A. Versa-Flo™ Valves/
Versa-Flo™ Micro Valves
- B. Roto Stream™ Valves
- C. Power Massage® Jets
- D. Power Stream® Jets
- E. Cluster Jets
- F. Mini Jets
- G. Deluxe Jets
- H. Storm Jets
- I. Vortex Jet™ Circulation
- J. Relax Stream™ Waterfall
- K. Footwell Spa Drain
- L. Backlit Digital Control Panel
- M. Microban® Filtration
- N. Toploading Skimmer
- O. Pillows
- P. Mood Light
- Q. Projet Stream™
- R. Projet Stream™ Valve
- S. Master-Flo™ Massage

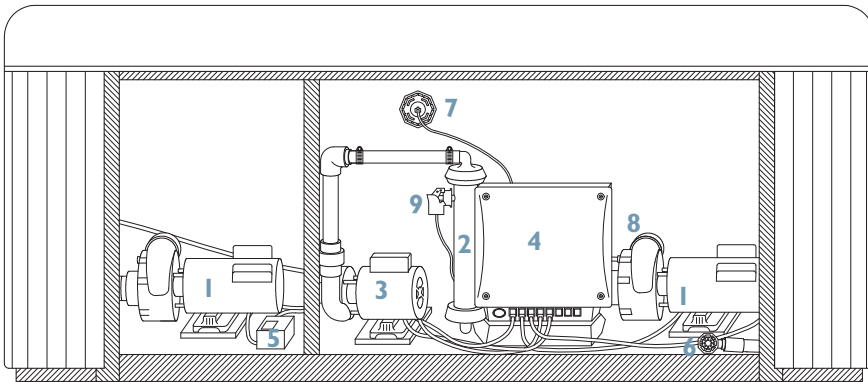
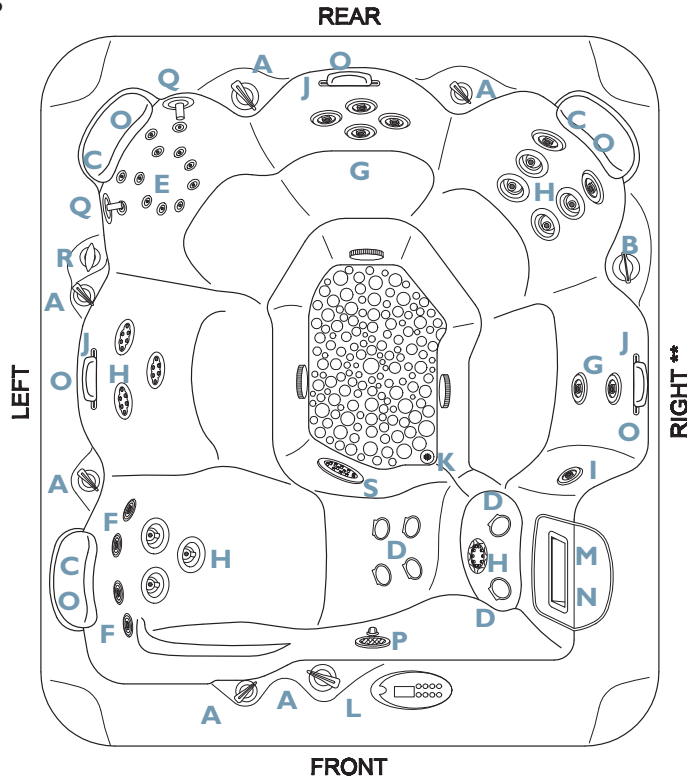

Regent SARATOGA SPA OPERATIONS CENTER

- 1. (2) Dual Speed Hydro Pumps
- 2. 4 kW heater
- 3. Purity Circulation™ Pump
- 4. 220V Power Pak
- 5. Whisper Zone™ Ozonator
- 6. Drain Valve
- 7. Mood Light
- 8. Bonding Terminal
- 9. Pressure Switch

Lincoln SPA FEATURES

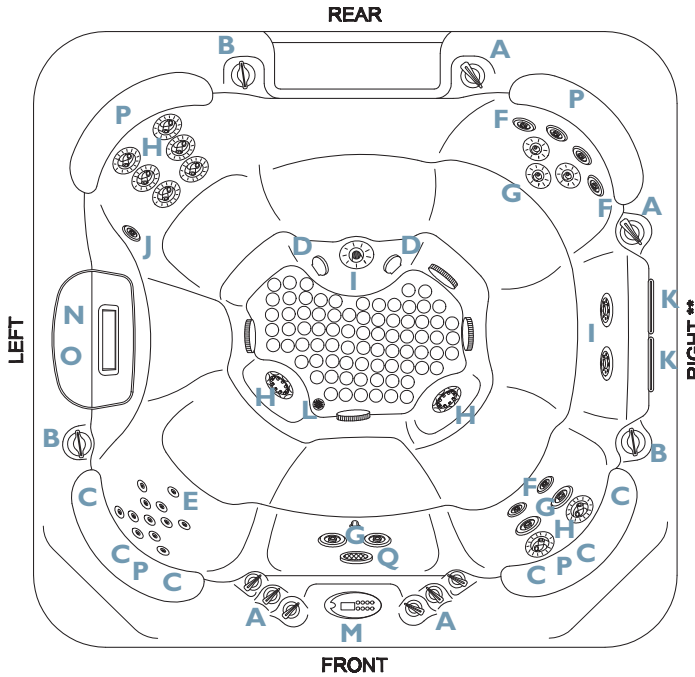

- A. Versa-Flo™ Valves/
Versa-Flo™ Micro Valves
- B. Roto Stream™ Valves
- C. Power Massage® Jets
- D. Power Stream® Jets
- E. Cluster Jets
- F. Mini Jets
- G. Deluxe Jets
- H. Storm Jets
- I. Turbo Jets
- J. Vortex Jet™ Circulation
- K. Relax Stream™ Waterfall
- L. Footwell Spa Drain
- M. Backlit Digital Control Panel
- N. Microban® Filtration
- O. Toploading Skimmer
- P. Pillows
- Q. Mood Light

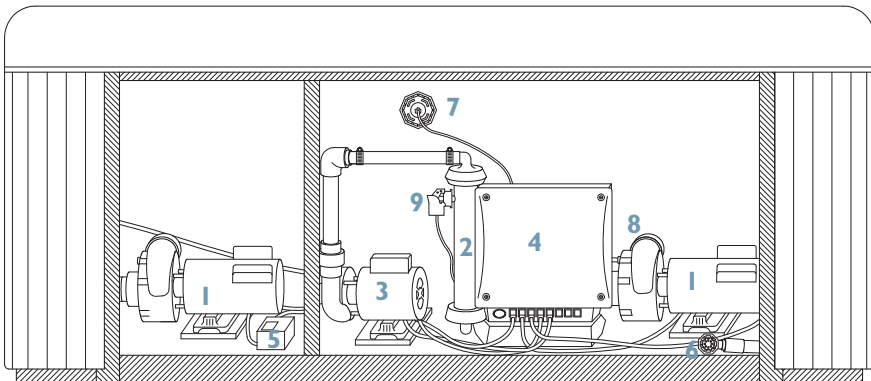

Lincoln SARATOGA SPA OPERATIONS CENTER

1. (2) Dual Speed Hydro Pumps
2. 4 kW heater
3. Purity Circulation™ Pump
4. 220V Power Pak
5. Whisper Zone™ Ozonator
6. Drain Valve
7. Mood Light
8. Bonding Terminal
9. Pressure Switch

Empire SPA FEATURES

- A. Versa-Flo™ Valves/
Versa-Flo™ Micro Valves
- B. Roto Stream™ Valves
- C. Power Massage® Jets
- D. Power Stream® Jets
- E. Cluster Jets
- F. Mini Jets
- G. Deluxe Jets
- H. Storm Jets
- I. Vortex Jet™ Circulation
- J. Relax Stream™ Waterfall
- K. Footwell Spa Drain
- L. Backlit Digital Control Panel
- M. Microban® Filtration
- N. Toploading Skimmer
- O. Pillows
- P. Master-Flo™ Massage
- Q. Satellite Controls
- R. Mood Light
- S. Projet Stream™
- T. Projet Stream™ Valve

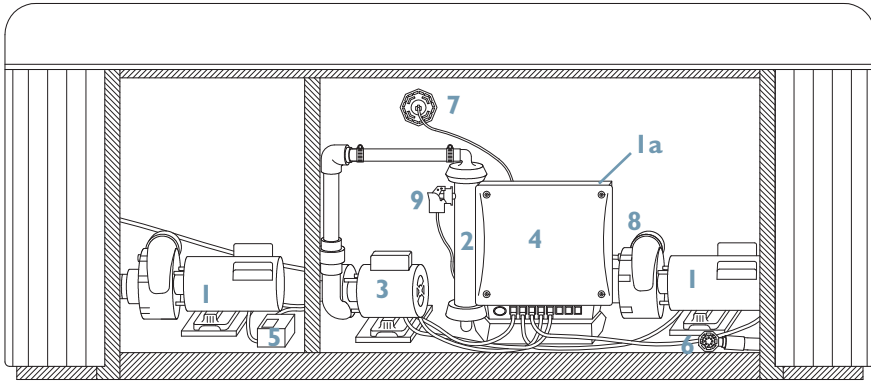
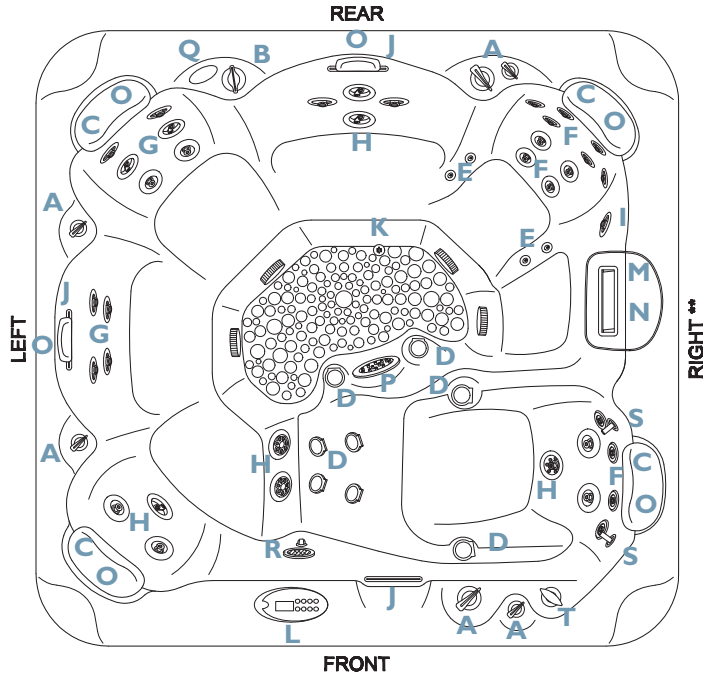

Empire SARATOGA SPA OPERATIONS CENTER

- 1. (2) Dual Speed Hydro Pumps
- 1a. (1) Uni Speed Hydro Pump (behind Power Pak)
- 2. 4 kW heater
- 3. Purity Circulation™ Pump
- 4. 220V Power Pak
- 5. Whisper Zone™ Ozonator
- 6. Drain Valve
- 7. Mood Light
- 8. Bonding Terminal
- 9. Pressure Switch

Broadway SPA FEATURES

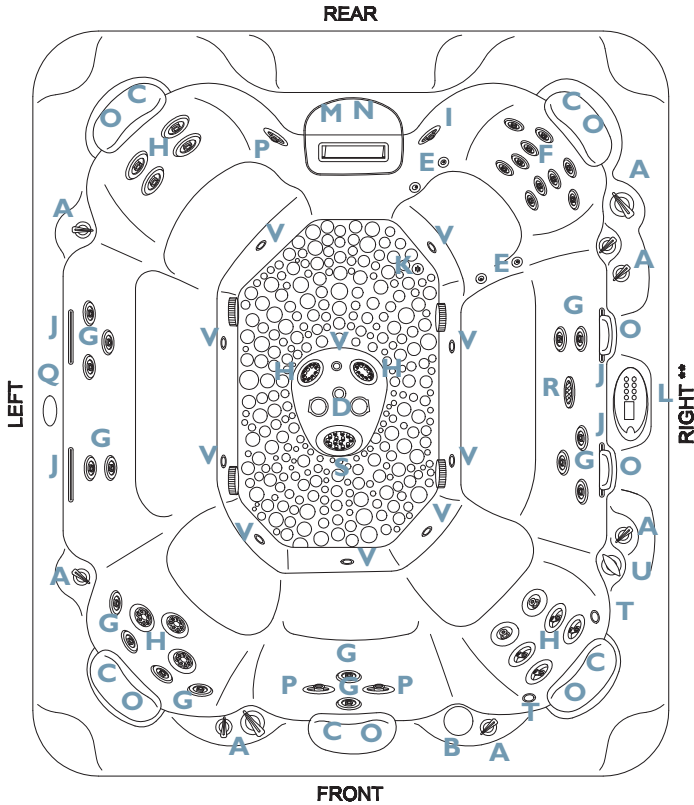

- A. Versa-Flo™ Valves/
Versa-Flo™ Micro Valves
- B. Moto Stream™ Valves
- C. Power Massage® Jets
- D. Power Stream® Jets
- E. Cluster Jets
- F. Mini Jets
- G. Deluxe Jets
- H. Storm Jets
- I. Vortex Jet™ Circulation
- J. Relax Stream™ Waterfall
- K. Footwell Spa Drain
- L. Backlit Digital Control Panel
- M. Microban® Filtration
- N. Toploading Skimmer
- O. Pillows
- P. Turbo Jets
- Q. Satellite Controls
- R. Mood Light
- S. Master-Flo™ Massage
- T. Projet Stream™
- U. Projet Stream™ Valve
- V. Turbo Boost Air System

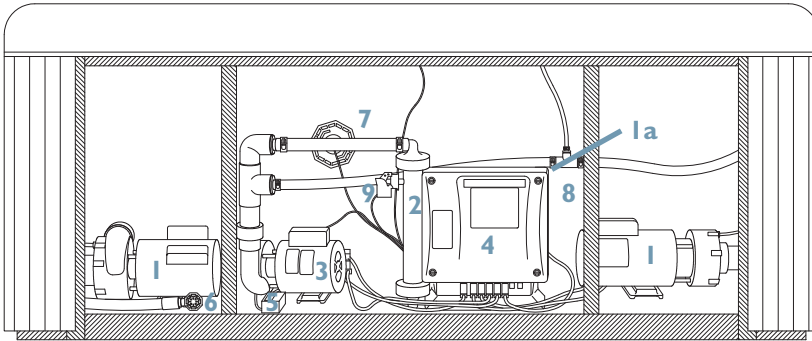

Broadway SARATOGA SPA OPERATIONS CENTER

- 1. (2) Dual Speed Hydro Pumps
- 1a. (1) Uni Speed Hydro Pump (behind Power Pak)
- 2. 4 kW heater
- 3. Purity Circulation™ Pump
- 4. 220V Power Pak
- 5. Whisper Zone™ Ozonator
- 6. Drain Valve
- 7. Mood Light
- 8. Bonding Terminal
- 9. Pressure Switch

Lexington Plus SPA FEATURES

- A. Versa-Flo™ Valves/ Versa-Flo™ Micro Valves
- B. Roto Stream™ Valves
- C. Power Massage® Jets
- D. Cluster Jets
- E. Mini Jets
- F. Deluxe Jet
- G. Master-Flo™ Massage
- H. Vortex Jet™ Circulation
- I. Footwell Spa Drain
- J. Relax Stream™ Waterfall
- K. Backlit Digital Control Panel
- L. Microban® Filtration
- M. Toploading Skimmer
- N. Pillows
- O. Mood Light

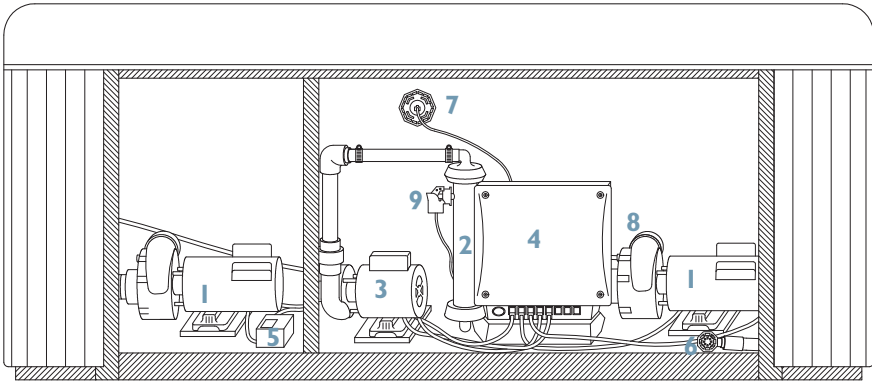
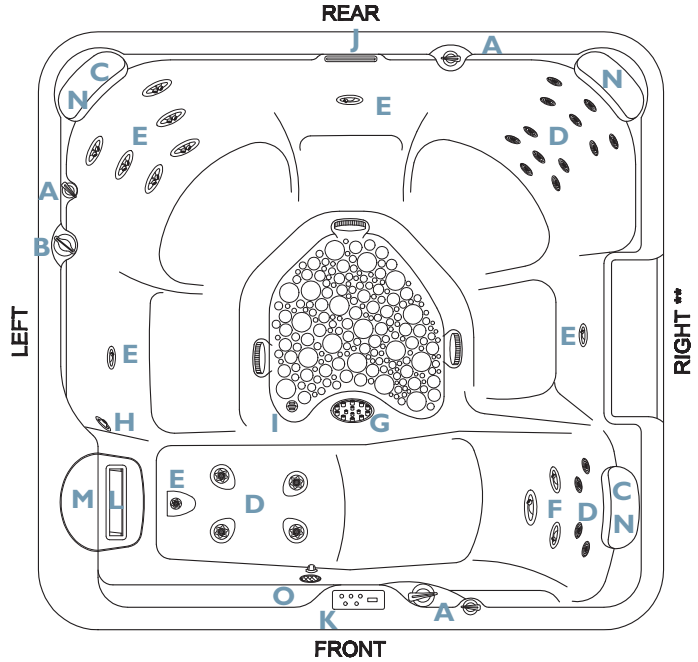

Lexington Plus SARATOGA SPA OPERATIONS CENTER

- 1. (2) Dual Speed Hydro Pumps
- 2. 4 kW heater
- 3. Purity Circulation™ Pump
- 4. 220V Power Pak
- 5. Whisper Zone™ Ozonator
- 6. Drain Valve
- 7. Mood Light
- 8. Bonding Terminal
- 9. Pressure Switch

Clifton Plus SPA FEATURES

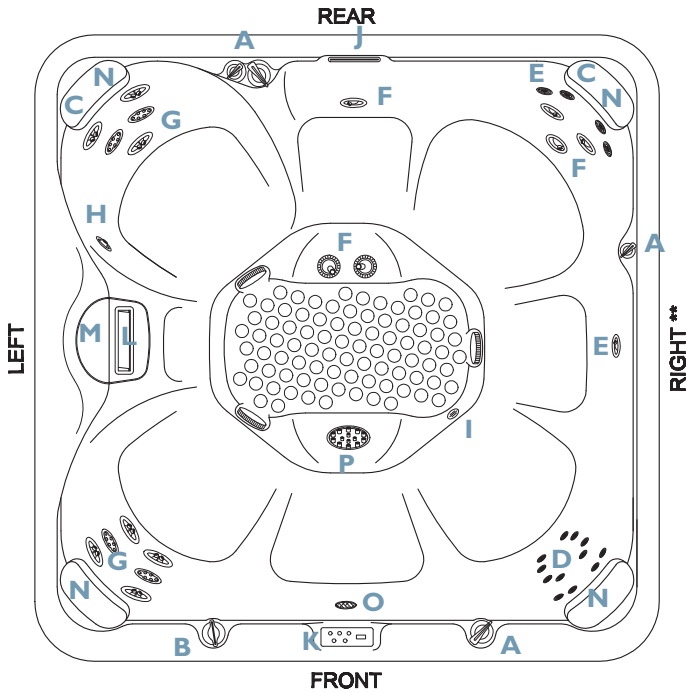

- A. Versa-Flo™ Valves/
Versa-Flo™ Micro Valves
- B. Roto Stream™ Valves
- C. Power Massage® Jets
- D. Cluster Jets
- E. Mini Jets
- F. Deluxe Jet
- G. Storm Jets
- H. Vortex Jet™ Circulation
- I. Footwell Spa Drain
- J. Relax Stream™ Waterfall
- K. Backlit Digital Control Panel
- L. Microban® Filtration
- M. Toploading Skimmer
- N. Pillows
- O. Mood Light
- P. Master-Flo™ Massage

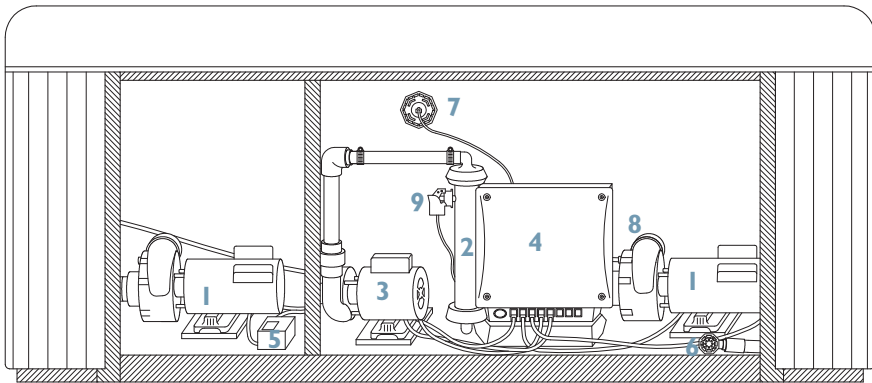

Clifton Plus SARATOGA SPA OPERATIONS CENTER

- 1. 2 Dual Speed Hydro Pumps
- 2. 4 kW heater
- 3. Purity Circulation™ Pump
- 4. 220V Power Pak
- 5. Whisper Zone™ Ozonator
- 6. Drain Valve
- 7. Mood Light
- 8. Bonding Terminal
- 9. Pressure Switch

Franklin Plus SPA FEATURES

- A. Versa-Flo™ Valves/
Versa-Flo™ Micro Valves
- B. Roto Stream™ Valves
- C. Power Massage® Jets
- D. Cluster Jets
- E. Mini Jets
- F. Deluxe Jet
- G. Storm Jets
- H. Master-Flo™ Massage
- I. Vortex Jet™ Circulation
- J. Footwell Spa Drain
- K. Relax Stream™ Waterfall
- L. Backlit Digital Control Panel
- M. Microban® Filtration
- N. Toploading Skimmer
- O. Pillows
- P. Mood Light

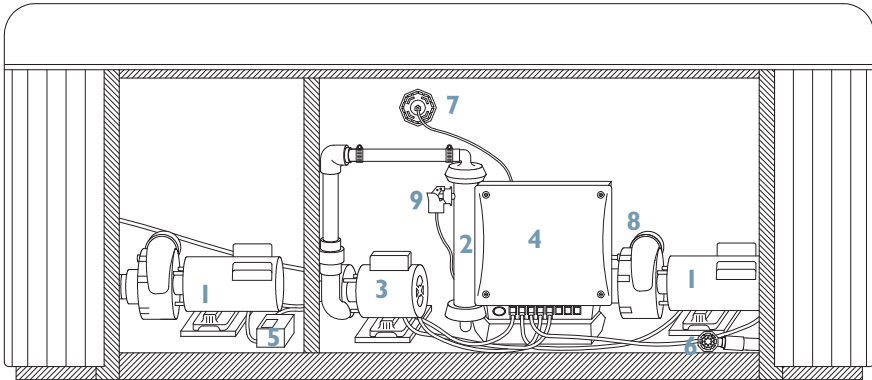
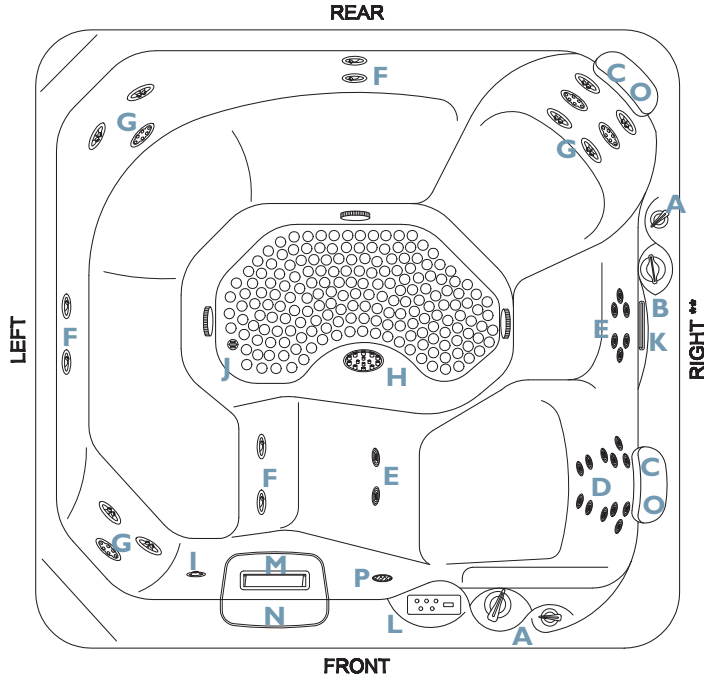

Franklin Plus SARATOGA SPA OPERATIONS CENTER

- 1. (2) Dual Speed Hydro Pumps
- 2. 4 kW heater
- 3. Purity Circulation™ Pump
- 4. 220V Power Pak
- 5. Whisper Zone™ Ozonator
- 6. Drain Valve
- 7. Mood light
- 8. Bonding Terminal
- 9. Pressure Switch

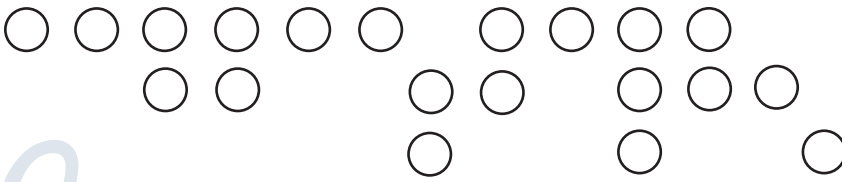

Installation Instructions

Location Preparation

Your Saratoga Spa is totally self-contained and portable. You can install the spa outside or inside. Preferable places are on a patio, deck or indoors. The spa should always be placed on a structurally strong, level surface. Other items you need to consider are the following:

- Verify that the location chosen can support the weight of the spa, the water of the spa and its occupants.
- Always check the surface of the site to see if it is level before filling the spa with water.
- Allow access to the equipment compartment for routine maintenance.
- When positioning the spa, be sure to allow for drainage away from the electrical compartment.
- Leave easy access to the GFCI breaker.

WARNING:

The Saratoga Spa is manufactured to be a portable unit. Any permanent installation of this product is done at the risk of the owner. Permanent installation of this unit violates warranty coverage.

Outdoor Installation

Always keep in mind what type of climate you live in. In a climate with cold, snowy winters you may want to consider locating the spa close to the house for easy access. In climates where it is normally warm or hot year-round, it would be recommended to place the spa in a shaded or cool area. With deck installations it is recommended that a qualified building contractor or structural engineer review the weight the deck can support. The spa specification sheet (on page 6) can assist you with the weights and dimensions of your spa.

Indoor Installation

Special requirements are needed for indoor installation. Spas normally produce moisture. A ventilation system needs to be considered. Your spa area should contain moisture resistant wall/floor coverings and building materials to avoid damage from moisture over time. Proper drainage of the spas water also needs to be considered.

Important:

Your Saratoga Spa is equipped with air vents to allow for circulation of air throughout the equipment compartment. These vents are found on the face of the equipment compartment panel and under the corners of the spa at the equipment compartment end. Do not allow vents to be blocked as to prevent the circulation of air in the equipment compartment.

YOUR SARATOGA SPA DEALER CAN HELP YOU WITH INFORMATION SUCH AS LOCAL ZONING REGULATIONS AND BUILDING CODES.

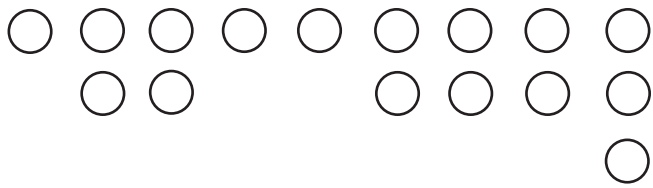

Electrical Requirements and Precautions:

Your Saratoga Spa has gone through numerous tests to verify that all the spas functions operate. Beyond the tests, your Saratoga Spa has been designed to provide the maximum safety against electrical shock. Read and follow the electrical installation requirements and instructions completely. The next few pages will assist you in properly connecting the electrical input. Follow the electrical instructions for your specific spa model. Serious risks or injuries may occur if the spa is improperly wired.

220 Volt Permanently Connected Models:

-Polo	-Adelphi	-Putnam	-Regent
-Excelsior	-Canfield	-Empire	-Lincoln
-Lexington Plus	-Clifton Plus	-Franklin Plus	-Broadway

Saratoga Spas must be wired in accordance with all applicable local electrical codes. All electrical work should be done by an experienced, licensed Electrician. We recommend the use of appropriate electrical conduit, fittings and wire for all circuits.

220 Volt installations require a 60Hz, single phase, three-wire electrical service plus ground (Line 1, Line 2, Neutral and Ground) and must be connected using a minimum supply conductor ampacity of 50 AMPs and a minimum circuit breaker size of 50 AMPs. Note: Use copper wire only (3 wire with ground. 8 gauge under 50', 6 gauge over 50')

220 Volt model spas must be connected to a “dedicated” 220 volt 50 Amp grounded circuit. The term “dedicated” means the electrical circuit is not being used for any other electrical items (lights, appliances, etc.). If the spa is connected to a non-dedicated circuit, overloading will occur and nuisance tripping of the GFCI breaker switch at the house breaker panel will occur.

A ground lug connector is provided on the exterior surface of the spa pack (operations center) inside the equipment compartment. This is to permit the connection of a bonding wire between this point and any metal equipment, enclosures, pipe or conduit within five feet (1.5m) of the spa. This bonding wire must be at least 8AWG solid copper wire.

Important:

Use only approved pressure-type wire splicing lugs or connectors suitable for the size and type of wiring used!

Electrical Installation Instructions for 220 Volt Models

1. To connect the electrical service, first remove the screws from the equipment compartment door. Carefully remove the access panel.
2. Locate the blue “M-Class” spa control box. Loosen the screws on the front of the control box. Remove the screws and the control box cover.
3. Input the electrical service from the GFCI breaker into the spa equipment compartment.

Note: The GFCI breaker must be placed in sight of the spa, at a minimum distance of five feet (1.5m) away.

Note: As of January 1, 1996 the National Electric Code (NEC) requires GFCI (Ground Fault Circuit Interrupter) on all spa installations.

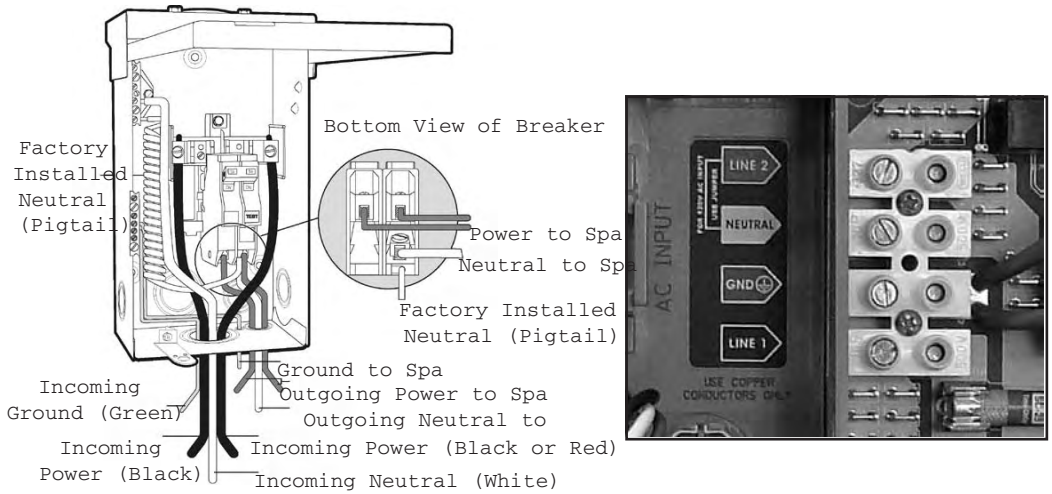

Electrical Spa Wiring Connection Instructions

Wiring Connections

Important:

Never, under any circumstances, should you connect power to the neutral terminal.

1. Identify the TB-1 terminal block, located inside the blue “M-Class” control box on the left side.
2. Connect the 8 AWG, BLACK wire, from the GFCI 50 amp breaker, terminal L1 to TB-1, Line 1.
3. Connect the 8 AWG, WHITE wire, from the GFCI 50 amp breaker, terminal N to TB-1, neutral.
4. Connect the 8 AWG, GROUND wire, from the GFCI 50 amp breaker, terminal GND (ground) to TB-1, ground.
5. Connect the 8 AWG, RED wire, from the GFCI 50 amp breaker, terminal L2 to TB-1, Line 2.
6. At least two additional lugs marked “Bonding Lugs” are provided on the external surface of one of the bonded components metal enclosures. To reduce the risk of electrical shock, connect the local common bonding grid in the area of the hot tub or spa to these terminals with an insulated or bare copper conductor not smaller than No. 6 AWG.
7. All field-installed metal components such as rail, ladders, drains or other similar hardware within 10 ft (3m) of the spa or hot tub shall be bonded to the equipment grounding bus with copper conductors not smaller than No. 6 AWG.
8. Replace the control box cover and securely tighten the fastening screws. Close and secure the equipment compartment panel.

Note: Always use copper wire only (3 wire with ground. 8 gauge under 50ft, 6 gauge over 50ft) The electrical supply for this product must include a suitable rated switch or circuit breaker to open all ungrounded supply conductors to comply with Section 422.20 of the National Electrical Code ANSI/NEPA 70-1987. The disconnecting means must be readily accessible to the tub occupant but installed at least 5 feet (1.5m) from tub water.

110 / 220 Volt Convertible Models

- Polo
- Putnam
- Adelphi

110 Volt Electrical Requirements:

The above models are manufactured with the SC-MP 110V/220V convertible spa pack. The units are factory wired for 220 Volt applications with 4 kW heater operation. The models can be converted for 110 Volt applications and to run with a 1 kW heater operation.

The 110 Volt models must be connected to a “dedicated” 110 Volt 20Amp grounded circuit. The term “dedicated” means the electrical circuit is not being used for any other electrical items (lights, appliances, etc.). If the spa is connected to a non-dedicated circuit, overloading will occur and nuisance tripping of the GFCI breaker switch at the house breaker panel or GFCI cord will occur. Never connect the spa to an extension cord.

The 110 Volt models may be optionally equipped with a GFCI power cord (approximately 13 feet long). These models must be plugged into a grounding type, 110 Volt 20 Amp receptacle as shown below. No other electrical appliances or fixtures should be used on this circuit.

DEDICATED 110V, 20A RECEPTACLE

Data label amperage rating of 16 Amps must use this type of 20 Amp dedicated receptacle and plug.

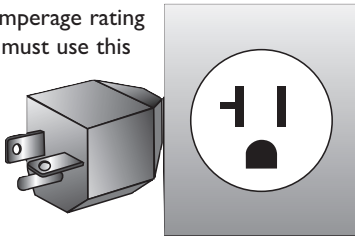

DEDICATED 110V, 15A RECEPTACLE

DO NOT USE THIS TYPE

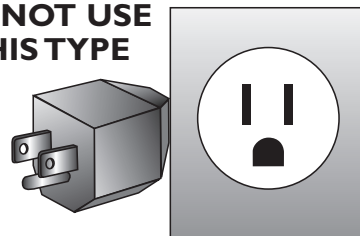

WARNING:

The use of any other receptacle or the connection of the plug to a 220 Volt service may cause the spa pack to operate improperly, create the potential for an electrical hazard and may void the spas warranty.

Saratoga Spa models must be wired in accordance with all local electrical codes. All electrical work should be done by an experienced, licensed electrician familiar with spa installations.

Note: As of January 1, 1996 the National Electrical Code (NEC) requires a GFCI (Ground Fault Circuit Interrupter) on all spa installations.

Installation Instructions:

The following instructions are for the conversion of the SC-MP 110V/220V control pack from a 220 Volt application to a 110 Volt application.

Important:

Use only approved pressure-type wire splicing lugs or connectors suitable for the size and type of wiring used.

Before servicing the spa, make sure all power to the spa is disconnected. Follow the following instructions for a successful electrical installation.

1. Unscrew the screws on the front access panel.
2. Carefully pull access panel towards you (away from spa) and pull upward. Set access panel aside.
3. Locate the blue SC-MP 110V/220V spa control box. Loosen the screws on the front of the control box. Lift the control box cover upward and the terminal block will be exposed.
4. Route the GFCI power cord through the vent hole in the base of the equipment compartment and out from under the corner of the spa.
NOTE: 110 Volt installations require a 60Hz, single phase, two-wire electrical service plus ground (Line 1, Neutral and Ground) and must be connected using a minimum supply conductor ampacity of 20 Amps and a minimum GFCI circuit breaker size of 20Amps.
5. Input the GFCI power cord to the terminal block inside the spa pack.
6. Connect the #8 AWG black wire, from the power cord, to Line 1 on the input terminal block.
7. Connect the #8 AWG ground wire, from the power cord, to the GND (ground) on the input terminal block.
8. Connect the #8 AWG white wire, from the power cord, to the neutral on the input terminal block.
9. Place a jumper cable between the neutral and Line 2 at the input terminal block.
10. Locate Jumper #1 on the PC board (see wiring diagram) and move Jumper #1 to the right position (low current mode).
11. Close spa pack cover and re-tighten screws.

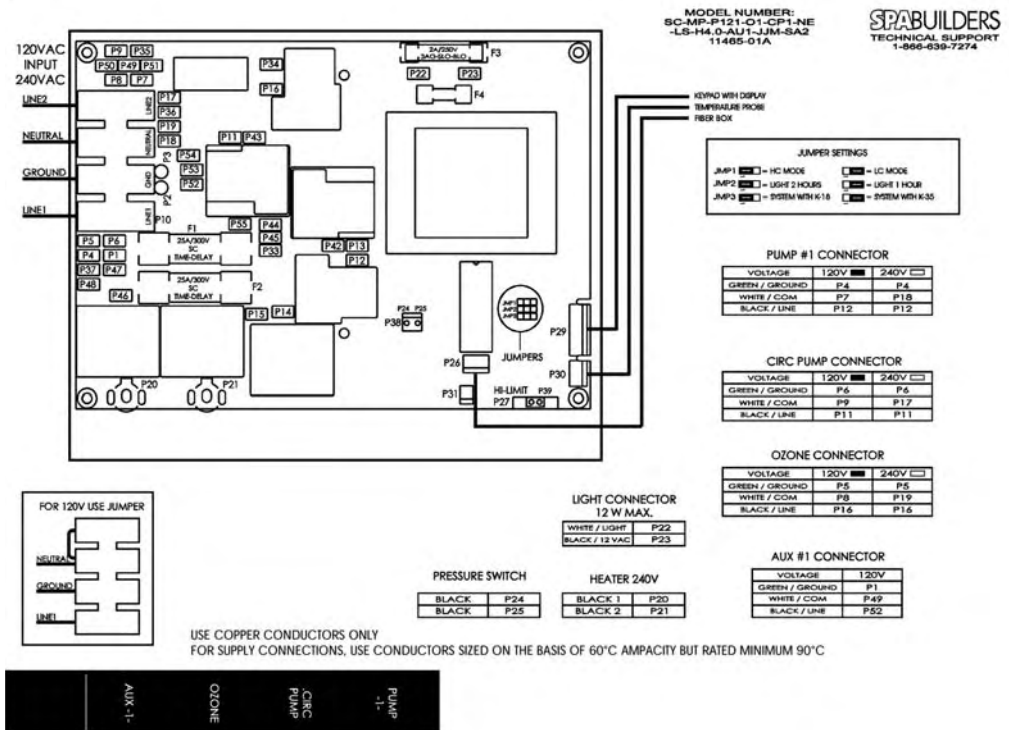

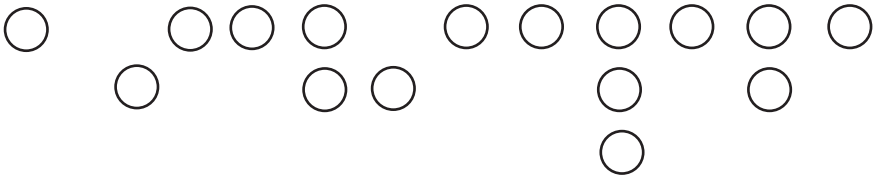

Initial Operating Instructions:

Start-Up and Refill Procedures

Your Saratoga Spa has been tested at the manufacturing plant to ensure that all the spas functions operate. During the test procedure, a small amount of water may have remained in the spas plumbing. Through the shipping process water may have spotted the spas shell. You may need to wipe down the shell with a soft cloth. Please read and follow the start-up instructions to ensure a successful start-up or refill.

Important:

- **Inspect and clean spa shell of any debris**
- **Do not turn power on to spa unless filled with water to appropriate level (See Page 25). The spa pack must never be operated without water in the spa; serious damage to the heater and/or pump(s) may result.**
- **Do not fill spa with water before checking the items below (below items may become loose in transit):**

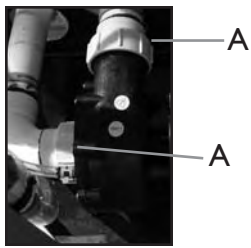

a) **Hand tighten unions at the pumps**



b) **Tighten drain valve**

Note: Drain Valve is left open for shipping - drain valve must

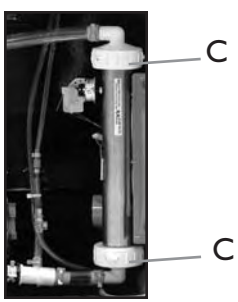

c) **Tighten unions on heater**

- **Do not fill spa with hot water. This may cause a false error code to the high limit sensor.**

Start-up Procedures

- I. For a successful start-up, fill the spa with water through the Whisper Clean® cartridge. The Whisper Clean® cartridge is the cartridge with the coarse threaded yellow ACME style adapter.
 - a. Locate the filter compartment area.



Note: The Lincoln model uses three filters.

- b. Pull up and remove filter cover.
 - c. Remove the filter cartridge and screen adapter by turning them counter clockwise.
 - d. After removing the filter cartridge and screen adapter, place a garden hose through the filter opening.
 - e. At this point, open the air bleeder valve(s) in your filter compartment by turning counter clockwise.



- f. Turn water on and run water until it reaches a minimum level of 2” above the top of the filters.

Note: Besides filling the spa to 2” above the top of the filter, all models will need to be filled to 2” above the highest jet(s) in the spa. This is the minimum level allowed to run the Whisper Clean® circulation system.

Note: When using a mineral cartridge system, please refer to your dealer for specific instructions on installation.

2. Check all plumbing (clamps, unions and drain valve) connections for leaks.
3. Re-install filter cartridges and screen adapters by turning them clockwise. Exit garden hose from the spa.

4. At this point, turn power on to the spa control system by turning on the GFCI breaker. The MSPA operations center will begin heating the spa to the factory set temperature of 95°F (35°C).
5. The next step is to check that the jet system(s) are operational. Press on the Jet(s) button to turn on the pump(s). A strong force of water flowing through the jets indicates the pump(s) are primed. Weak or surging jet(s) indicates the pump(s) still need to be primed (see Troubleshooting section).
6. Once pump(s) are primed, close the air bleeder valve(s) in the filter compartment.

Note: Water will be exiting from the air bleeder valves.

7. Re-install filter cover and allow spa to heat to desired set temperature; this normally takes 24 hours. 110 Volt models may take up to 48 hours to reach desired set temperature.
8. 24 hours after initial start-up the spa will go through its first power filtration cycle. Jets 2 (pump 2), Jets 3 (pump 3) and optional Blower will run on high speed for one (1) minute. Then Jet 1 (pump 1) will turn on and run on low speed for one (1) minute. This power filtration cycle is repeated every 24 hours at the exact time as initial power-up.

Note: If water bubbles are not coming out of the Whisper Clean® Jet/bottom drain, the system is air locked. Refer to the Trouble Shooting Section on page 60 for further instructions.

Note: It is recommended to press and release the ground fault circuit interrupter (GFCI) RESET button monthly to verify GFCI is working properly.

Note: If power is interrupted, and the conserve filtration cycle has been activated, it will be reset to the continuous 24 hour cycle.

9. Water must be balanced and shocked upon start-up. See your dealer or pages 57–59 of this manual for details. This procedure must be repeated each time the spa is drained and refilled.

10. *The Whisper Clean® Jet*

The combination of the Whisper Clean® and Vortex Jet™ return systems help the Whisper Clean® System circulate water from the surface and bottom level of the spa. The Whisper Clean® Jet also induces temperature controlled water and ozone into the spas footwell area 24 hours a day.

Note: A slow or non-moving Whisper Clean® Jet may indicate that the filter cartridge pores are obstructed with dirt, body oils or calcification. Follow the filter cartridge cleaning procedures in this manual (See page 53).





Versa-Flo™ Jets and CFE™ Jet Descriptions

*Power Massage Plus® and Power Massage®**

Patented jet provides dual water massage to your neck or back from under the built-in headrest. The jet is controlled by a small selector valve, giving the bather total control.

* Provides a single ribbon of water flow parallel to the body



Power Stream®

Underwater jet patterned after the Power Massage®. This jet runs a ribbon of water parallel to the surface of the spa body. Not found in all units.



Cluster Jet

The Cluster Jet provides a concentrated stream of water and air for precise pressure point areas.



Mini Swirl Jet (Mini Jet Category)

The Mini Swirl Jet has an adjustable eyeball for directional or rotational use. To change from directional to rotational, with finger, simply adjust inner nozzle to the rotating position.



Cyclo Swirl Jet (Deluxe Jet Category)

A larger version of the Mini Swirl Jet, this jet gives a mid-size rotational massage and pulsating massage. To change from directional to rotational, with finger, simply adjust inner nozzle to the rotating position.



ProJet Stream™

Provides precise neck and shoulder massage. Retractable design is hydro driven and allows for personalized use.



Cyclo Flo Jet (Deluxe Jet Category)

This jet provides a balanced mix of air and water to give a soft, powerful, direct pressure massage to mid-size muscle groups. The design allows for higher GPM for performance and maximum relief.



Twin Rotational Jet (Storm Jet Category)

This jet provides multiple adjustment for varied rotational intensities.



Turbo Jet

Provides an intense lower body massage and whirlpool stimulation through a large orifice.



Xtreme-Flo™ Jet (Storm Jet Category)

The Xtreme Flo jet provides a mix of water and air. To change from a straight stream to directional, with finger, move inner nozzle to position desired.



Gatling Jet (Storm Jet Category)

A rotating dual nozzle, diffused by seven holes, creates a pulsating body massage.



Veri-Flo™ Massage Jet (Storm Jet Category)

Multiple pressure point flow, provides foot and large muscle relief.



Master-Flo™ Massage Jet

A larger version of the Veri Massage Jet, this jet delivers multiple pressure point flow into several locations of muscle area and has an interchangeable design that gives relief to a variety of areas.



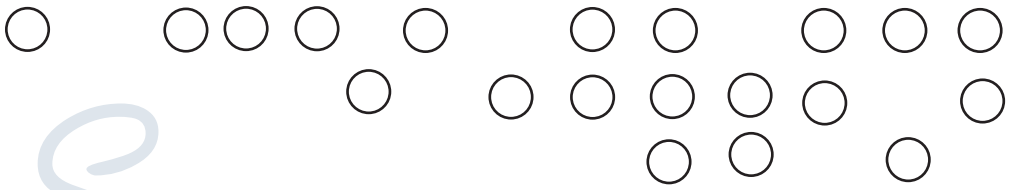

Saratoga Spa Jet Selectors

The Jets in the Saratoga Spa Luxury Line have different ways to adjust the jet therapy systems. While having the Hydro Jet pump(s) on the user has the ability to turn on and off each individual Versa-Flo™ Jet. The Versa-Flo™ Jet(s) can be turned on and off by turning the outer scallop on the face of the jet. In addition to having the ability to control each individual jet, the jets can be adjusted by zones. Saratoga Spa uses five different ways to adjust the jet therapy zones. The Roto Stream™ Valves, Moto Stream™ Valves, ProJet Stream™ Valves, Versa-Flo™ Valves, and Versa-Flo™ Micro Valves give the user the ability to control the different Jet Therapy Zones. The following pages will discuss the different jet therapy zones found in the Luxury Line Spas and Select Plus Systems.



Versa-Flo™ Valve

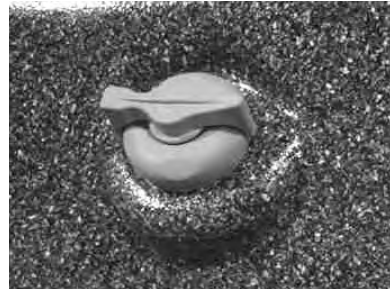

Versa-Flo™ Micro Valve

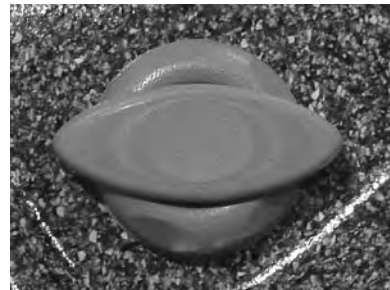

Jet Therapy Zones

This example will help you to understand the following pages that discuss the jet system menus. The navigational tool was read from standing outside of the spa and in front of the particular selector. Keep this in mind when the following pages discuss 12,3,6 or 9 o'clock position settings. The Versa-Flo™ Valve, and Versa-Flo™ Micro Valve can only be rotated 180°. The Roto Stream™ Valve can be rotated 360°.

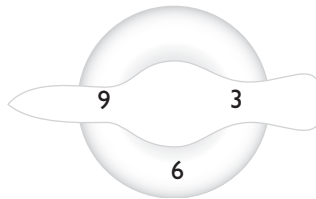
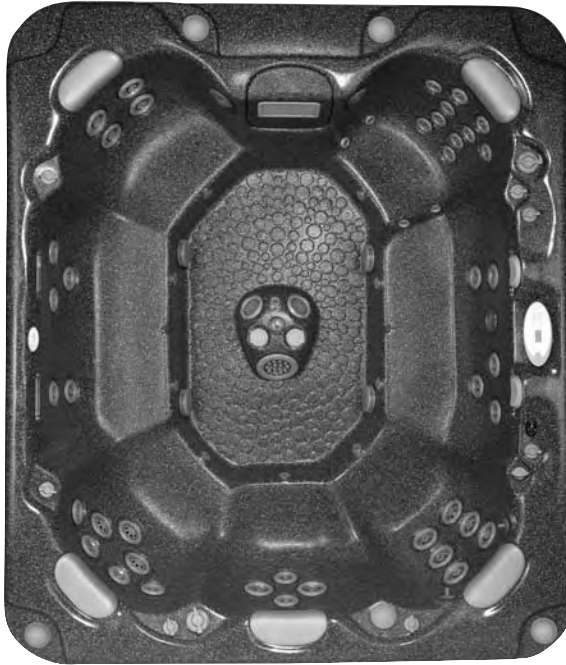

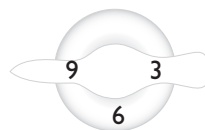
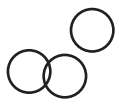

1 - VERSA-FLO™ MICRO VALVE

- Controls the Power Massage® Jet 1A
- Setting the Versa-Flo™ Micro valve to the 9, 12 or 3 o'clock positions will turn on the different settings in the Power Massage Plus® Jet 1A.

2 - VERSA-FLO™ VALVE

- Controls the jets in lounge seat 2B and the jets in footwell area 2A
- Setting the Versa-Flo™ valve to the 9 o'clock position activates the jets in the lounge seat 2B.
- The 3 o'clock position turns on the two Power Stream® jets and the one Versa-Flo™ Jet in the footwell area 2A.

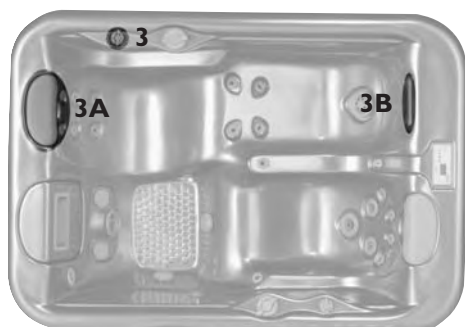

3 - VERSA-FLO™ MICRO VALVE

- Setting the Versa-Flo™ Micro valve to the 3 o'clock position activates the Power Massage® Jet 3A.
- The 9 o'clock setting turns on the Relax Stream™ 3B.

4 - ROTO STREAM™ VALVE

- Controls the entire seat and footwell area, 4A, 4B, and 4C.
- Adjusting the Roto Stream™ valve to different positions will allow different jets to be activated in 4A, 4B, and 4C.

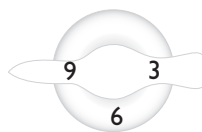
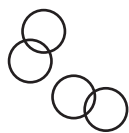

1 - VERSA-FLO™ MICRO VALVE

- Controls the amount of water flowing through the Power Massage® Jet 1A.
- Setting the Versa-Flo™ Micro valve to the 3 or 9 o'clock position will turn on the Power Massage® Jet 1A.
- The 12 o'clock position reduces the Power Massage® Jet 1A.

2 - ROTO STREAM™ VALVE

- Controls the 6 jets in seat 2A.
- Adjusting the Roto Stream™ valve to different settings allows for certain jets to come on in seat 2A.



3 - VERSA-FLO™ MICRO VALVE

- Controls the jets in seat 3A and the Relax Stream™ 3B
- Setting the Versa-Flo™ Micro valve to the 9 o'clock position turns on the jets in seat 3A.
- The 3 o'clock position turns on the Relax Stream™ 3B.

4 - VERSA-FLO™ MICRO VALVE

- Controls the jets in seat 4B and the Power Massage® jet behind pillow 4A
- Setting the Versa-Flo™ Micro valve to the 3 o'clock position turns on the jets in seat 4B.
- The 9 o'clock position turns on the Power Massage® jet behind pillow 4A.

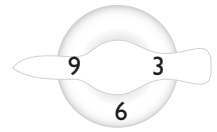
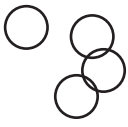

JET 1 HYDRO PUMP ACTIVITIES

All Jets in Spa

1 - ROTO STREAM™ VALVE

- The Roto Stream™ valve controls the six Versa-Flo™ Jets 1A.



2 - VERSA-FLO™ MICRO VALVE

- Versa-Flo™ Micro valve allows the user to adjust the Power Massage® Jet 2A or the Relax Stream™ 2B.



3 - VERSA-FLO™ MICRO VALVE

- By adjusting the Versa-Flo™ Micro valve the user is able to adjust the amount of water flowing through the Power Massage® Jet 3A.
- Versa-Flo™ Micro valve is able to be positioned from the 3, 12 or 9 o'clock positions.



4 - THE VERSA-FLO™ VALVE

- Controls the jets in zones 4A and 4B.
- Setting the Versa-Flo™ valve to the 3 o'clock position will turn on the jets in zone 4A.
- The 9 o'clock position allows the jets in zone 4B to turn on.

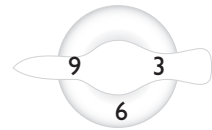

1 - VERSA-FLO™ MICRO VALVE

- Controls the Power Massage® Jet 1A and the Relax Stream™ 1B.
- Setting the Versa-Flo™ Micro valve to the 3 o'clock position turns on the Power Massage® Jet 1A.
- The 9 o'clock position turns on the Relax Stream™ 1B.



2 - VERSA-FLO™ VALVE

- Controls the jets in lounge seat 2A and the jets in calf area 2B
- Setting the Versa-Flo™ valve to the 3 o'clock position turns on the jets in the lounge seat 2A.
- The 9 o'clock position turns on jets in calf area 2B.



3 - ROTO STREAM™ VALVE

- Controls the jets in seat 3A.
- The rotating of the Roto Stream™ valve allows the user to select the sequence best for them.

4 - VERSA-FLO™ MICRO VALVE

- Controls the Power Massage® Jet 4A
- Setting the Versa-Flo™ Micro valve to the 9 or 3 o'clock positions will turn on the Power Massage® Jet 4A.
- The 6 o'clock position turns off the Power Massage® Jet 4A.



5 - VERSA-FLO™ VALVE

- Allows you to control the jets in seat 5A and the two Power Stream® Jets in footwell area 5B.
- Setting the Versa-Flo™ valve to the 3 o'clock position turns on the jets in seat 5A.
- The 9 o'clock position turns on the jets in the footwell area 5B.

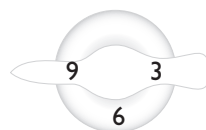

I - VERSA-FLO™ VALVE

- Controls the jets in the lounge seat zones IA and IB.
- Setting the Versa-Flo™ valve to the 9 o'clock position controls the seven jets in the lounge seat IA.
- The 3 o'clock position turns on four Power Stream® Jets IB.



2 - VERSA-FLO™ MICRO VALVE

- Controls the Power Massage® Jet 2A and Relax Stream™ 2B.
- Setting the Versa-Flo™ Micro valve to the 3 o'clock position controls Relax Stream™ 2B.
- The 9 o'clock position activates Power Massage® Jet 2A.

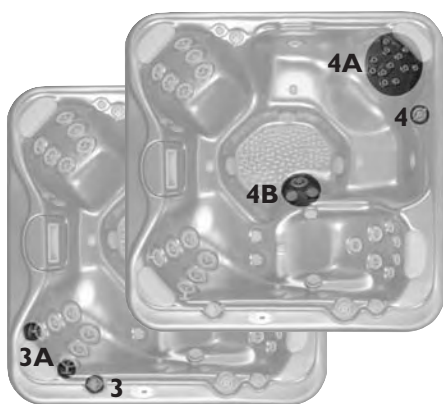

3 - PROJET STREAM™ VALVE

- Controls the Projet Stream™ 3A
- Setting the Projet Stream™ valve to the 9 o'clock position activates the Projet Stream™.
- The 3 o'clock position turns off the Projet Stream™.

4 - VERSA-FLO™ VALVE

- Controls bucket seat 4A and three jets in footwell area 4B.
- Setting the Versa-Flo™ valve to the 9 o'clock position turns on jets in seat 4A.
- The 3 o'clock position turns on jets in footwell area 4B.

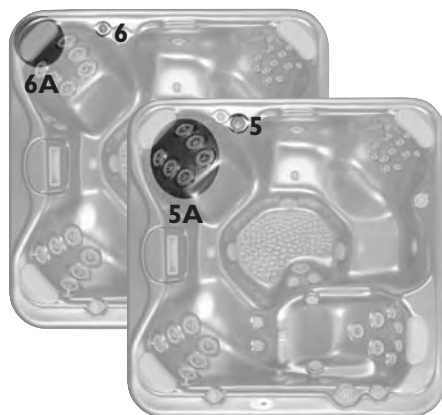

5 - ROTO STREAM™ VALVE

- Controls the six Versa-Flo™ Jets 5A.
- Controls six jets in valve seat 5A at different levels depending on setting.

6 - VERSA-FLO™ MICRO VALVE

- Allows control of the Power Massage® Jet 6A.
- Setting the Versa-Flo™ Micro valve to the 3 or 9 o'clock position turns on the Power Massage® Jet 6A.
- The 12 o'clock position reduces the Power Massage® Jet 6A.

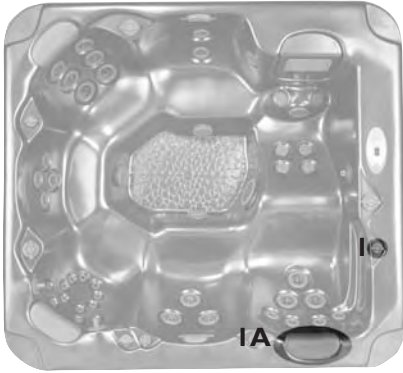
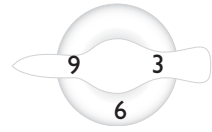
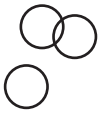

1 - VERSA-FLO™ MICRO VALVE

- Controls the Power Massage® Jet 1A.
- Setting the Versa-Flo™ Micro valve to the 3 or 9 o'clock position turns on the Power Massage® Jet 1A.
- The 12 o'clock position reduces the Power Massage® Jet 1A.

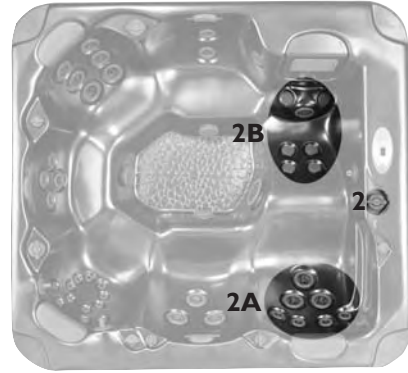

2 - VERSA-FLO™ VALVE

- Activates the different zones in the Lounge Seat 2A and 2B.
- Setting the Versa-Flo™ valve to the 3 o'clock position turns on the Jets in 2A.
- The 9 o'clock position turns on the Jets in zone 2B.

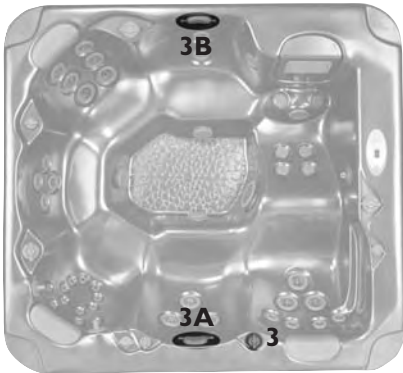

3 - VERSA-FLO™ MICRO VALVE

- Controls both Relax Streams™ 3A and 3B.
- Setting the Versa-Flo™ Micro valve to the 9 o'clock position activates the Relax Streams™ 3A and 3B.
- The 3 o'clock position turns off the Relax Streams™ 3A and 3B.



4 - VERSA-FLO™ MICRO VALVE

- Controls the Power Massage® Jet 4A and Relax Stream™ 4B.
- Setting the Versa-Flo™ Micro valve to the 9 o'clock position turns on the Power Massage® Jet 4A.
- The 3 o'clock position activates the Relax Stream™ 4B.

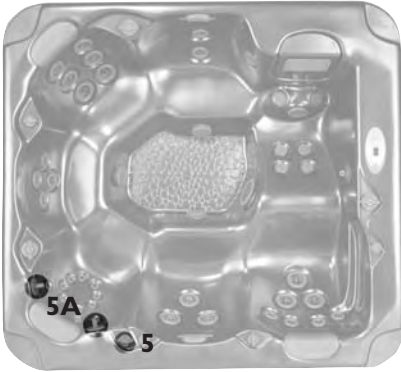
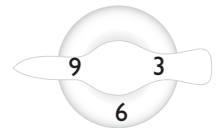
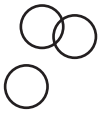

5 - PROJET STREAM™ VALVE

- Controls the Projet Stream™ 5A.
- Setting the Projet Stream™ valve to the 9 o'clock position turns on the Projet Stream™ 5A.
- The 3 o'clock position turns off the Projet Stream™ 5A.

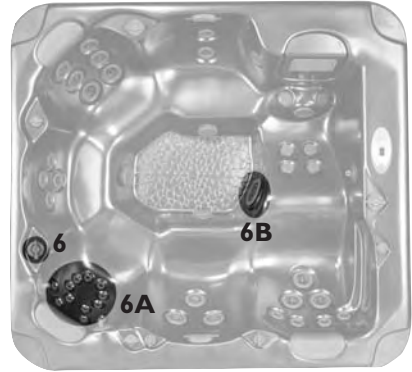

6 - VERSA-FLO™ VALVE

- Controls seat 6A and large Master-Flo™ Massage jet 6B.
- Setting the Versa-Flo™ valve to the 9 o'clock position will turn on the jet in the footwell 6B and will turn off the jets in seat 6A.
- The 6 o'clock position turns on both seat jets and the jet in the footwell 6B.
- The 3 o'clock position turns on seat jets 6A and turns off the jet in the footwell 6B.

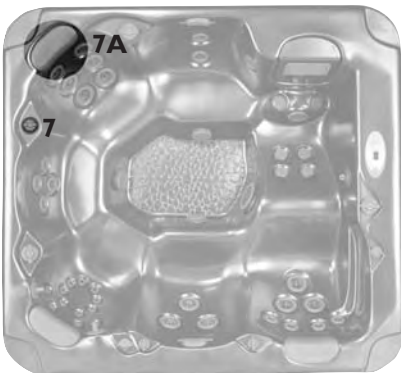

7 - VERSA-FLO™ MICRO VALVE

- Controls the amount of water flowing through the Power Massage® Jet 7A.
- Setting the Versa-Flo™ Micro valve to the 3 or 9 o'clock position turns on the Power Massage® Jet 7A.
- The 12 o'clock position reduces the Power Massage® Jet 7A.

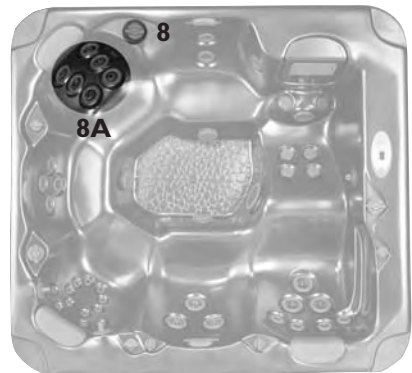

8 - ROTO STREAM™ VALVE

- Controls the 6 jets in seat 8A
- Adjusting the Roto Stream™ valve to a different settings allows for certain jets to come on in seat 8A.

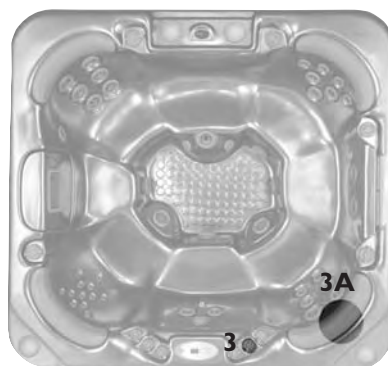
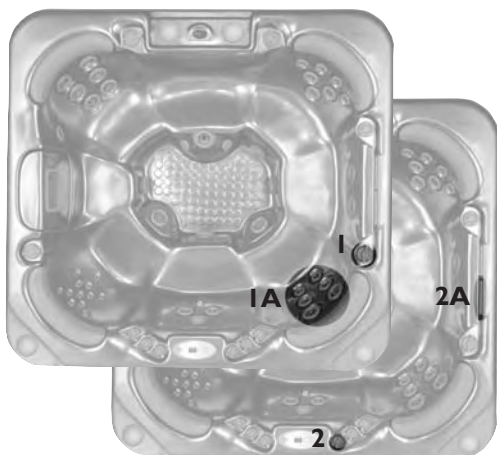
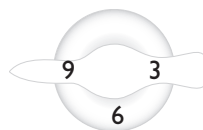

1 - ROTO STREAM™ VALVE

- Controls the six Versa-Flo™ Jets in seat 1A.

2 - VERSA-FLO™ MICRO VALVE

- Controls the Relax Stream™ 2A.
- Setting the Versa-Flo™ Micro valve to the 9 o'clock position activates the Relax Stream™ 2A.
- The 3 o'clock setting turns off the Relax Stream™ 2A.

3 - VERSA-FLO™ MICRO VALVE

- Controls the middle Power Massage® Jet 3A.
- Setting the Versa-Flo™ Micro valve to the 9 or 3 o'clock position will activate the Power Massage® Jet 3A.
- The 12 o'clock position reduces the Power Massage® Jet 3A.

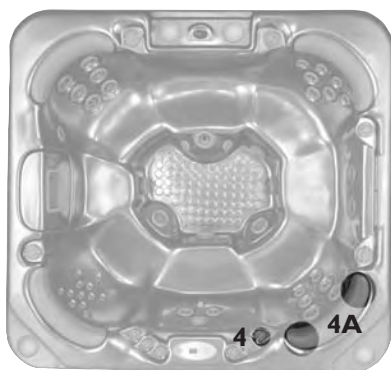

4 - VERSA-FLO™ MICRO VALVE

- Controls the two Power Massage® Jets 4A.
- Setting the Versa-Flo™ Micro valve to the 9 o'clock setting turns on the two Power Massage® Jets 4A.
- The 3 o'clock position turns off both Power Massage® Jets 4A.

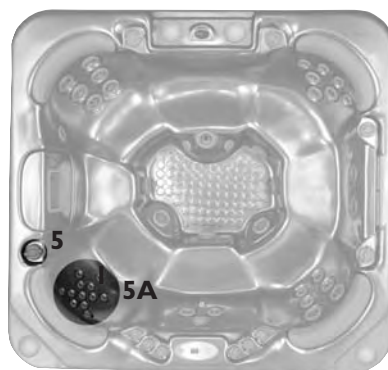

5 - ROTO STREAM™ VALVE

- Controls seat 5A. The turning of the Roto Stream™ valve allows the user to select which sequence is best for them.

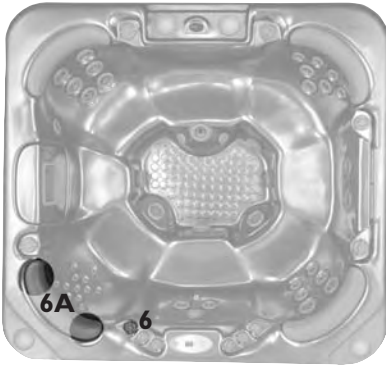
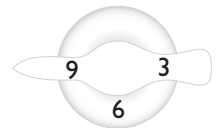
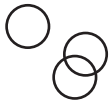

6 - VERSA-FLO™ MICRO VALVE

- Controls the two Power Massage® Jet 6A.
- Setting the Versa-Flo™ Micro valve to the 3 o'clock position activates the Power Massage® Jet 6A.
- The 9 o'clock position turns off the Power Massage® Jet 6A.

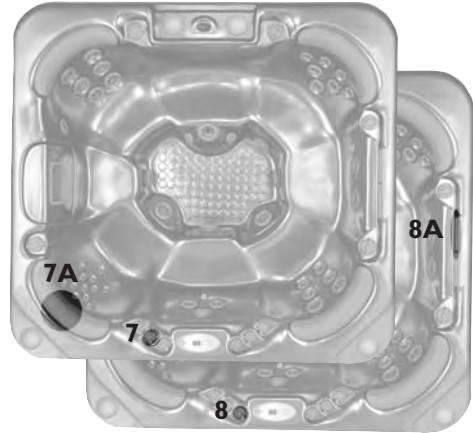

7 - VERSA-FLO™ MICRO VALVE

- Controls the third Power Massage® Jet 7A.
- Setting the Versa-Flo™ Micro valve to the 3 or 9 o'clock position will activate the different settings on the Power Massage® Jet 7A.

8 - VERSA-FLO™ MICRO VALVE

- Allows for control of the second Relax Stream™ 8A.

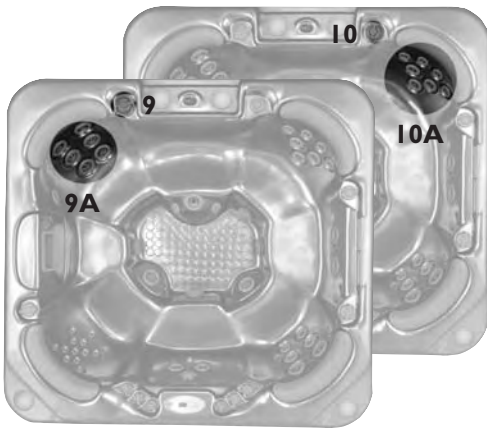

9 - ROTO STREAM™ VALVE

- Controls the jets in seat 9A.
- Rotating the Roto Stream™ valve allows the user to select the sequence best for them.

10 - VERSA-FLO™ VALVE

- Controls the jets in seat 10A.
- Setting the Versa-Flo™ valve to the 9 o'clock position turns on the jets in seat 10A.
- The 3 o'clock position turns off the jets in seat 10A.

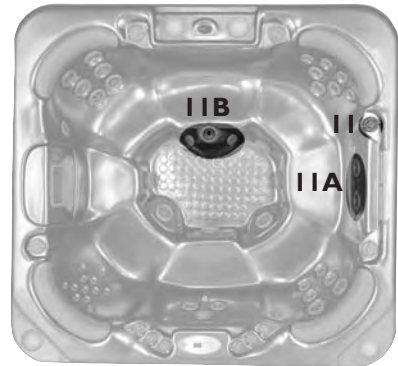

11 - VERSA-FLO™ VALVE

- Controls the two wall jets 11A and the footwell jet 11B.
- Setting the Versa-Flo™ valve to the 3 o'clock position will activate the two wall jets 11A. The footwell jet will be off 11B.
- The 9 o'clock position will activate the footwell jet 11B and will turn off the two wall jets 11A.

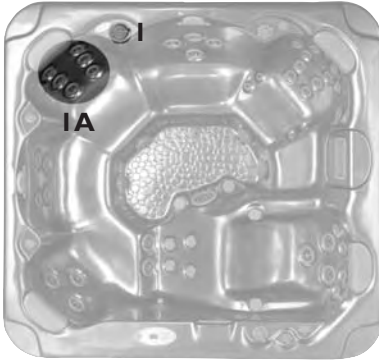
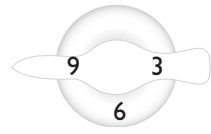

1 - ROTO STREAM™ VALVE

- Controls jets in seat IA.
- By rotating the Roto Stream™ valve allows the user to select the sequence best for them.

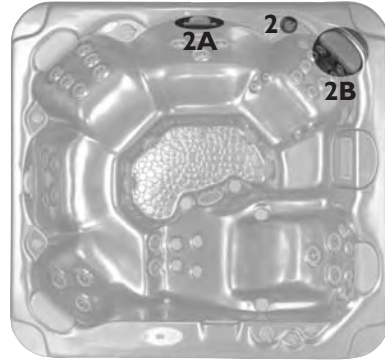

2 - VERSA-FLO™ MICRO VALVE

- Controls the Relax Stream™ 2A and the Power Massage® Jet 2B.
- Setting the Versa-Flo™ Micro valve to the 9 o'clock position turns on the Relax Stream™ 2A and turns off the Power Massage® Jet 2B.
- The 3 o'clock position will activate the Power Massage® Jet 2B and will turn off the Relax Stream™ 2A.

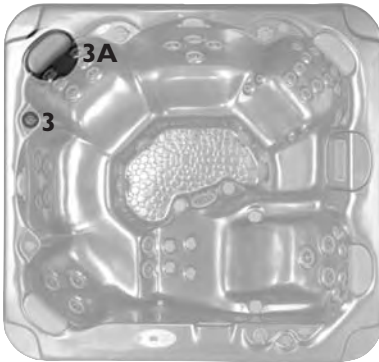

3 - VERSA-FLO™ MICRO VALVE

- Controls the Power Massage® Jet 3A.
- Setting the Versa-Flo™ Micro valve to the 3 or 9 o'clock position will turn on the Power Massage® Jet 3A.
- The 12 o'clock position reduces the Power Massage® Jet 3A.

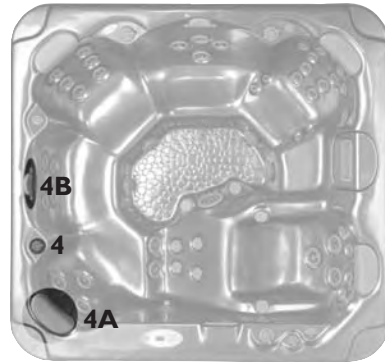

4 - VERSA-FLO™ MICRO VALVE

- Controls the third Power Massage® Jet 4A and Relax Stream™ 4B
- Setting the Versa-Flo™ Micro valve to the 3 o'clock position will turn on the Relax Stream™ 4B and turn off the Power Massage® Jet 4A
- The 9 o'clock position will activate the Power Massage® Jet 4A and turn off the Relax Stream™ 4B

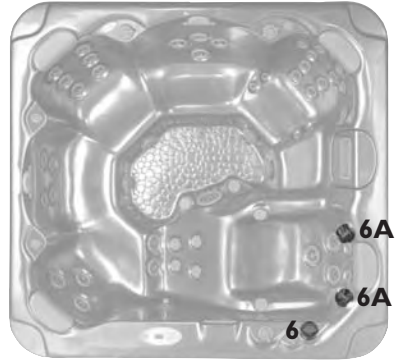
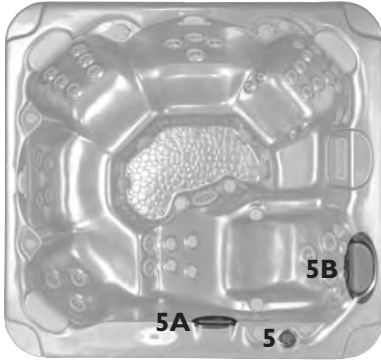
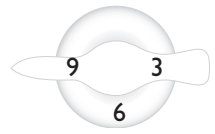
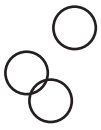

5 - VERSA-FLO™ MICRO VALVE

- Controls the Relax Stream™ 5A, and the Power Massage® Jet 5B
- Setting the Versa-Flo™ Micro valve to the 9 o'clock position will turn on the Relax Stream™ 5A and turn off the Power Massage® Jet 5B
- The 3 o'clock position will activate the Power Massage® Jet 5B and turn off the Relax Stream™ 5A

6 - PROJET STREAM™ VALVE

- Controls the two Projet Stream™ 6A.
- Setting the Projet Stream™ valve to the 9 o'clock position activates the Projet Stream™ 6A.
- The 3 o'clock position turns off the Projet Stream™ 6A.

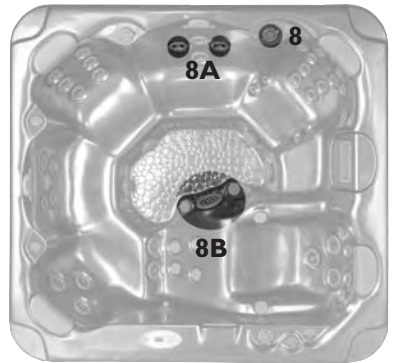
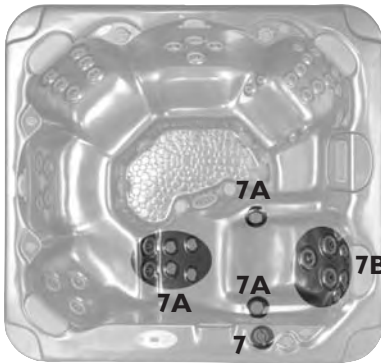

7 - VERSA-FLO™ VALVE

- Controls the jets in zones 7A and seat 7B
- Setting the Versa-Flo™ valve to the 9 o'clock position turns on the jets in zone 7A.
- The 3 o'clock position turns on the jets in seat 7B.

8 - VERSA-FLO™ VALVE

- Controls the sidewall jets 8A, and footwell jets 8B.
- Setting the Versa-Flo™ valve to the 9 o'clock position activates jets in footwell area 8B.
- The 3 o'clock position turns on the jets in sidewall area 8A.

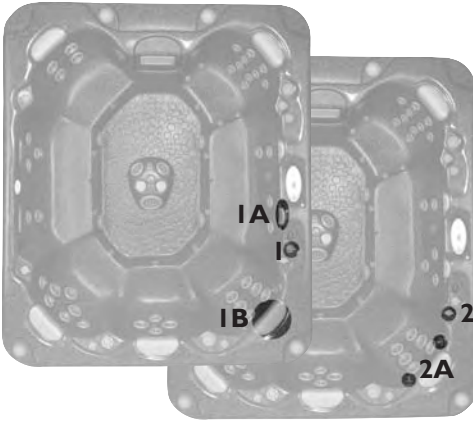
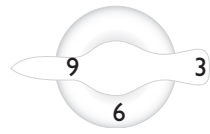
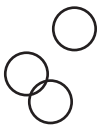

1 - VERSA-FLO™ MICRO VALVE

- Controls the Relax Stream™ 1A, and the Power Massage® Jet 1B
- Setting the Versa-Flo™ Micro valve to the 3 o'clock position activates the Relax Stream™ 1A.
- The 9 o'clock position turns on the PowerMassage® Jet 1B.

2 - PROJET STREAM™ VALVE

- Controls the Projet Stream™ 2A.
- Setting the Projet Stream™ valve to the 9 o'clock position activates the Projet Stream™ 2A.
- The 3 o'clock position turns off the Projet Stream™ 6A.

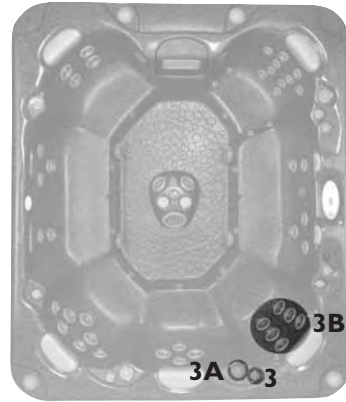

3 - VERSA-FLO™ MICRO VALVE

- Controls the Moto Stream™ valve 3A.
- The Moto Stream™ valve activates the six Versa-Flo™ Jets in seat 3B at different settings
- Setting the Versa-Flo™ Micro valve to the 3 o'clock position turns off the Moto Stream™ valve 3A and the six jets in seat 3.
- The 9 o'clock position turns on the Moto Stream™ valve 3A and activates the six jets in seat 3B.

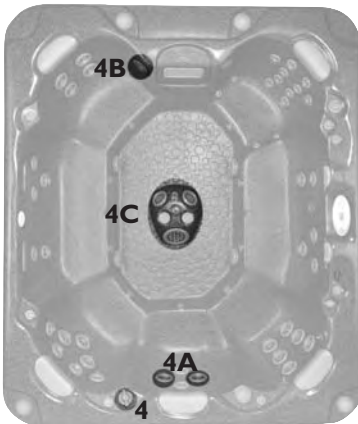

4 - VERSA-FLO™ VALVE

- Controls the two wall jets 4A, the wall jet 4B jets, and the jets in footwell area 4C.
- Setting the Versa-Flo™ valve to the 9 o'clock position turns on the wall jets in zones 4A and 4B.
- The 3 o'clock position turns on the jets in zone 4c.



5 - VERSA-FLO™ MICRO VALVE

- Controls the Power Massage Plus® Jet 5A.
- Setting the Versa-Flo™ Micro valve to the 9, 12, or 3 o'clock position the different settings in the Power Massage Plus® jet 5A will turn on.

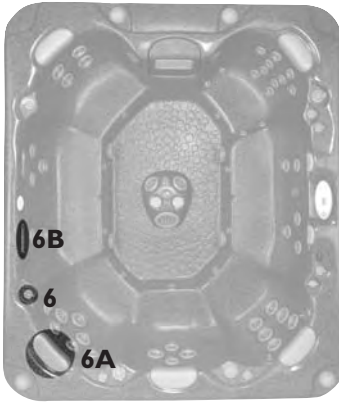
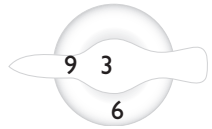
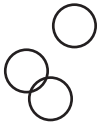

6 - VERSA-FLO™ MICRO VALVE

- Controls the Power Massage® Jet 6A and the Relax Stream™ 6B.
- Setting the Versa-Flo™ Micro valve to the 9 position o'clock activates the Power Massage® Jet 6A
- The 3 o'clock position turns on the Relax Stream™ Jet 6B.

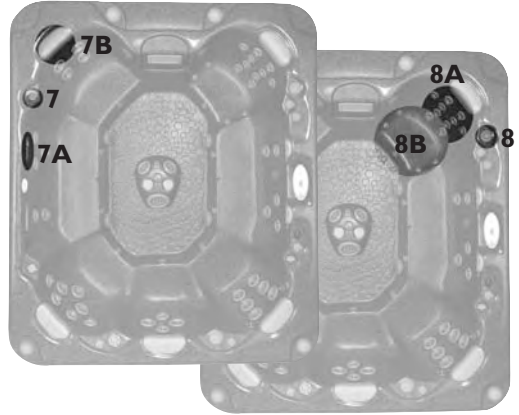

7 - VERSA-FLO™ MICRO VALVE

- Controls the Power Massage® Jet 7B and the Relax Stream™ 7A.
- The 9 o'clock position turns on the Power Massage® Jet 7B
- The 3 o'clock position turns on the Relax Stream™ Jet 7A.

8 - VERSA-FLO™ VALVE

- Controls the two zones 8A and 8B.
- Setting the Versa-Flo™ valve to the 3 o'clock position activates jets in zone 8B.
- The 9 o'clock position turns on the jets in zone area 8A.

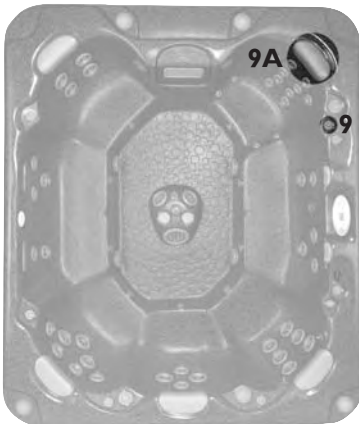

9 - VERSA-FLO™ MICRO VALVE

- Controls the Power Massage® Jet 9A
- Setting the Versa-Flo™ Micro valve to the 12, 3, or 9 position o'clock adjusts the amount of water flowing through the Power Massage® Jet 9A

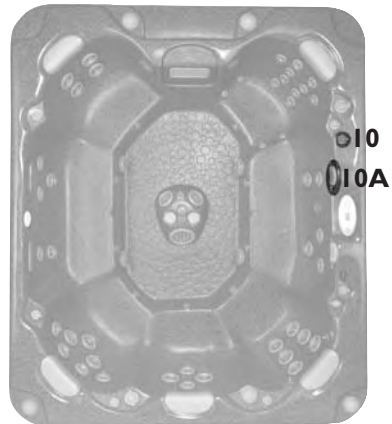

10 - VERSA-FLO™ MICRO VALVE

- Controls the the Relax Stream™ 10A.
- Setting the Versa-Flo™ valve to the 3 o'clock position activates the Relax Stream™ 10A.
- The 9 o'clock position turns off Relax Stream™ 10A

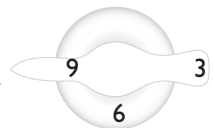

1 - ROTO STREAM™ VALVE

- Controls the jets in seat 1A.
- The adjustment of the Roto Stream™ valve allows the user to select which sequence is best for them.

2 - VERSA-FLO™ MICRO VALVE

- Controls the Power Massage® Jet 2A.
- Setting the Versa-Flo™ Micro valve to the 3 or 9 o'clock position will turn on the Power Massage® Jet 2A.
- The 12 o'clock position reduces the Power Massage® Jet 2A

3 - VERSA-FLO™ VALVE

- Controls the jets in seat 3B and the large Master-Flo™ Massage jet in footwell 3A.
- Setting the Versa-Flo™ valve to the 9 o'clock position will turn on the jet in the footwell 3A and will turn off jets in seat 3B.
- The 12 o'clock position turns on both seat jets and the jet in the footwell 3A.
- The 3 o'clock setting turns on seat 3B and turns off the jet in the footwell 3A.



4 - VERSA-FLO™ VALVE

- Controls the jets in the lounge seat.
- Setting the Versa-Flo™ valve to the 9 o'clock position activates the jets in zones 4A. The jets in zones 4B will be turned off.
- The 3 o'clock position activates the jets in zones 4B. The jets in zones 4A will be turned off.

5 - VERSA-FLO™ MICRO VALVE

- Controls the Relax Stream™ 5B and the Power Massage® Jet 5A
- Setting the Versa-Flo™ Micro valve to the 3 o'clock position turns on the Relax Stream™ 5B and turns off the Power Massage® Jet 5A.
- The 9 o'clock position activates the Power Massage® Jet 5A and turns off the Relax Stream™ 5B.

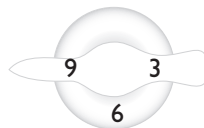

1 - VERSA-FLO™ VALVE

- Controls the jets in zone 1A.
- Setting the Versa-Flo™ valve to the 3 o'clock position will turn on the jets in zone 1A.
- The 9 o'clock position will turn off the jets in zone 1A.



2 - VERSA-FLO™ MICRO VALVE

- Controls the amount of water flowing through the Power Massage® Jet 2A.
- Setting the Versa-Flo™ Micro valve to the 3 or 9 o'clock position will turn on the Power Massage® Jet 2A.
- The 12 o'clock position will reduce the Power Massage® Jet 2A.

3 - ROTO STREAM™

- Controls the jets in seat 3A.
- The turning of the Roto Stream™ valve allows the user to select which sequence is best for them.



4 - VERSA-FLO™ MICRO VALVE

- Controls the Power Massage® Jet 4A and the Relax Stream™ 4B.
- Setting the Versa-Flo™ Micro valve to the 3 o'clock position activates the Relax Stream™ 4B, turning the Power Massage® Jet 4A off.
- The 9 o'clock setting will turn on the Power Massage® Jet 4A and turn off the Relax Stream™ 4B.



5 - VERSA-FLO™ VALVE

- Controls the jets in seat 5A and the jets in footwell 5B.
- Setting the Versa-Flo™ valve to the 3 o'clock position will turn on the jets in the seat 5A and turn off the jets in the footwell 5B.
- The 9 o'clock position turns off the jets in the seat 5A, while the jets in footwell 5B will be on.

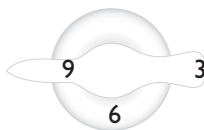
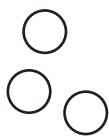

1 - VERSA-FLO™ MICRO VALVE

- Controls the Power Massage® Jet 1A and Relax Stream™ 1B.
- Setting the Versa-Flo™ Micro valve to the 12 o'clock position turns on the Power Massage® Jet 1A.
- The 6 o'clock position activates the Relax Stream™ 1B.

2 - VERSA-FLO™ VALVE

- Controls the jets in the seat 2A and the jet in the footwell 2B.
- Setting the Versa-Flo™ valve to the 12 o'clock position will turn on the jets in the footwell 2B and turn off the jets in seat 2A
- The 6 o'clock position will turn on the jets in the seat 2A and will turn off the jet in the footwell 2B.



3 - ROTO STREAM™ VALVE

- The Roto Stream™ valve controls the jets in seat 3A.
- The adjustment of the Roto Stream™ valve allows the user to select which sequence is best for them.

4 - VERSA-FLO™ MICRO VALVE

- The small Versa-Flo™ Micro valve allows for control of the Power Massage® Jet 4A.
- Setting the Versa-Flo™ Micro valve to the 3 or 9 o'clock position will turn on the Power Massage® Jet 4A.
- Pointing the Versa-Flo™ Micro valve to the 12 o'clock position will turn off the Power Massage® Jet 4A.

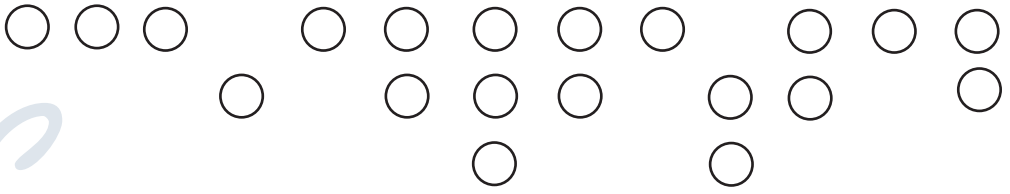

E Equipment Maintenance

Saratoga Spa Jet Valve Maintenance

After a period of time it may become difficult to adjust and rotate the valves. It is necessary to clean the valves to ensure that they continue to perform well. The following instructions will walk you through the steps.

1. Turn power off to the spa.
2. Un-thread valve cover by turning valve cover counter clockwise.
3. Remove complete valve assembly, by pulling outward.
4. Clean or remove debris from valve or diverter.
5. Re-assemble and re-thread valve cover.



Moto Stream™ Valve Maintenance (Broadway Model Only)

The Moto Stream™ valve is another unique feature that Saratoga Spa uses for Hydrotherapy. It is necessary to clean the valve to ensure that the Moto Stream™ valve continues to perform well. The following instructions will walk you through the steps in cleaning the valve and cleaning the built in cup strainer. It is recommended to clean the Moto Stream™ valve every time you drain your spa.

Cup Strainer Cleaning

1. Turn power off to the spa
2. Remove equipment access panel.
3. Drain Spa
4. Locate caretaker union in the equipment compartment.
5. Unthread union nut by turning counter clockwise.
6. Remove cup strainer and clean free of any debris.
7. Re-install cup strainer and align o-ring.
8. Thread union nut back together by turning nut clockwise.

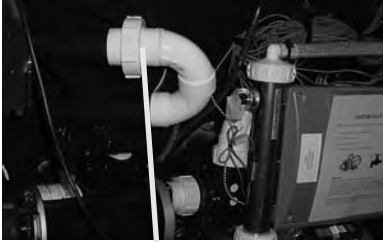

Caretaker Union



O-Ring

Union Nut

Valve Cleaning

1. Turn power off to the spa
2. With a flat head screwdriver pry the cap off of the valve
3. Unthread valve cover by turning valve cover counter clockwise
4. Pull diverter up and clean any debris by wiping with a damp soft cloth
5. Re-insert diverter and twist until unit locks back into place, then realign o-rings
6. Thread valve cover back on by turning clockwise.
7. Snap valve cap back on to valve cover



Replacing the Spa's Light Bulb

The spa's light bulb is located inside of the equipment compartment. Remove the front access panel, by first removing the screws on the access panel. Then locate the light housing mounted to the spa shell. Grasp the bulb holder on the back of the light niche. Turn bulb holder counter clockwise to release it from the light niche. Pull bulb out of receptacle and replace it with a new GE 912 bulb. Re-attach the light bulb holder to the light niche by turning the light bulb holder clockwise.

Note: Colored lenses for the underwater mood light are an option.

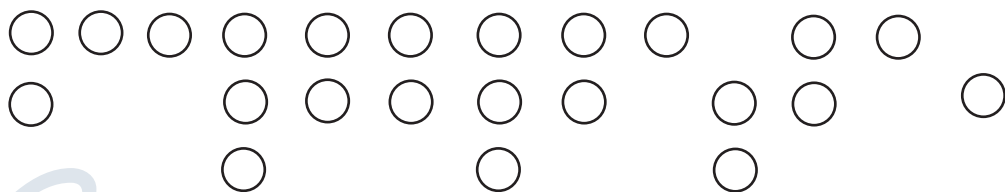

Control Panel Functions

Main Control Panel

The panel/topside will indicate the operations of the hydro jet pump(s), air blower, spa light, water temperature and will display diagnostic symbols.

Saratoga Spa models are equipped with a main control panel located on the top collar of the spa. The main control panel controls all of the spa functions. It displays the spa's status and any error messages. The main control panel and digital display are illuminated by a light from the inside of the panel.

The Empire and Broadway models have an additional satellite panel located across from the main control panel that allows the spa user to operate the jets and blower from the other side of the spa.

Main Control Panel Buttons and Digital Display

The main control panel has buttons which the spa user presses to set the temperature, vary the intensity of the light and activate or deactivate the hydro jet pump(s). The control panel also has a digital display that displays the spas diagnostics (ie-temperature setting, jet functions or error messages).

Temperature Control

The set temperature range is from 59°F (15°C) to 104°F (40°C). The set temperature of the spa water will automatically be 95°F (35°C) the first time that power is applied. This is the setting programmed at the factory. If power is disconnected from the spa, it will automatically revert to the last set temperature when power is reapplied.

To display the set temperature of the spa, press the Cool or Warm button once. The set temperature will be displayed unless the control panel is locked.

To increase the set temperature of the spa water, press the Warm button twice. Pressing the button once will display the current set temperature. Pressing the button again will increase the set temperature by one degree.

To decrease the set temperature of the spa water, press the cool button twice. Pressing the button once will display the current set temperature. Pressing the button again will decrease the set temperature by one degree.

Note: The temperature shown on the display without pressing on any of the temperature buttons reflects the temperature of the water at that particular moment.

Conserve Button

The Conserve button gives the user the ability to program the number of hours the spa filters. Your Saratoga Spa is factory programmed to filter 24 hours a day. By using the

Conserve button, the filtering cycles can be adjusted. Each filtration cycle setting will run twice in a 24 hour period. The filtration cycles can be adjusted from 0 to 12 (0 equals no filtering and 12 equals 24 hour filtering). To program the filtering cycles, press and hold the Conserve button until the topside window displays a two-digit number. Release the Conserve button and then use the warm or cool button(s) to reach the desired setting. Once the desired setting has been displayed in the topside window, press the Conserve button to confirm the setting. At that time the new filtration cycle will begin.

Note: Saratoga Spa does not recommend setting the filtration cycle to zero (0). Non-filtered water can create odors, become cloudy, and also be generally unhealthy.

Operating the Hydro Pumps

Jets 1 Button

Activates the hydro jet pump for maximum hydrotherapy jet action. Press Jets 1 button once for low speed (Jets 1 triangle icon will flash). Press Jets 1 button again for high speed and again to turn off (Jets 1 triangle icon will stay solid when Jets 1 is on high speed). Jets 1 will automatically shut off after 15 minutes of operation on low/or high speed.

Note: On Luxury Series 110V/220V systems there is only one speed on the jet pumps and the Jets will shut off after 20 minutes of operation.

Jets 2 Button

This button will activate the secondary hydro jet pump for additional hydrotherapy jet action. Press Jets 2 button once for low speed (Jets 2 triangle icon will flash). Press Jets 2 button again for high speed and again to turn off (Jets 2 triangle icon will stay solid when Jets 2 is on high speed). Pump will automatically turn off after 15 minutes of operation on high or low speed.

Jets 3 Button

(Empire and Broadway Models)

This button will activate the 3rd hydro jet pump. Press Jets 3 button once for high speed and again for off position (Jets 3 triangle icon will stay solid when pump is on). Pump will automatically turn off after 15 minutes of operation.



Option Button

Activates the 3 stage Blower. Press the Blower button once for high, again for medium again for low and then off. When operating, bubbles of air will come from air jets or Versa-Flo™ jets in the spa. Blower triangle icon will stay solid on high speed. Blower triangle icon will flash on medium or low speeds. The blower will turn off after 15 minutes of operation.

Note: The spa light will begin flashing 15 seconds before the pumps shut off as a reminder, that the pump(s) cycle is about to end.

Note: Saratoga spas are designed for maximum heat retention. The unit is not designed to cool water. If the set or desired temperature is below that of the ambient temperature, the unit will not be able to achieve this demand. Depending on the desired temperature, it may be necessary to add cool water to the unit to lower your spas water temperature.

Light Control Button

The intensity of the spa's light is controlled using the Light button. To turn on the spa light, press the Light button. The light will turn on at maximum intensity. To reduce the intensity of the light, press the Light button. To turn off the light, press the Light button a third time. If the light is left on it will automatically be turned off by the control system after four hours of continuous operation.

Note: On Luxury Series 110V/220V Systems the light will turn off after 2 hours.

Optional Color Blast or Color Splash Lighting

See operational features and directions located in Color Blast or Color Splash box, or contact your dealer for instructions.

Locking Features

There are two locking features: Minor temperature Lock and Major Spa panel Lock. The locking features are enabled from the main control panel. Once a locking feature is enabled, that particular locking feature will remain until cancelled by the user.

Major Spa Panel Lock

The Major Spa Panel Lock feature deactivates all of the functions of the main and satellite control panels. To activate the Major Panel Spa Lock, press and hold the option key until the letters "LocF" appear on the digital display (approximately 10-15 seconds). When the Major Spa Panel Lock is activated, if a button is pressed, the control panel will display the lock symbol "LocF". To deactivate the Major Spa Panel Lock, press and hold the option key until the letters "Uloc" appear on the digital display (approximately 10-15 seconds).

Minor Temperature Lock

The Minor Temperature Lock feature deactivates the temperature Warm or Cool buttons from the main control panel. All other functions on the main control panel will operate as normal. Minor Temperature Lock is most often used by people who do not want others to tamper with or change the set temperature of the spa water.

To activate the Minor Temperature Lock, press and hold the option key until the letters "LocP" appear on the digital display. When the Minor Temperature Lock is activated, the Jets, Light and option buttons will operate normally and the temperature setting can be viewed but can NOT be changed. If a temperature button is pressed, the control panel will display the lock symbol "LocP". To deactivate the Minor Temperature Lock, press and hold the option key until the letters "Uloc" appear on the digital display.

Note: Locking features not available on luxury Series 110V/220V systems.

Satellite Panel (Empire and Broadway only)

This smaller satellite panel is located on the spas opposite side of the main panel/topside control. All the features that are available for Jets 1, Jets 2, Jets 3 and Blower are accessible by using this smaller satellite panel. Temperature and light functions are not accessible through the smaller satellite panel.

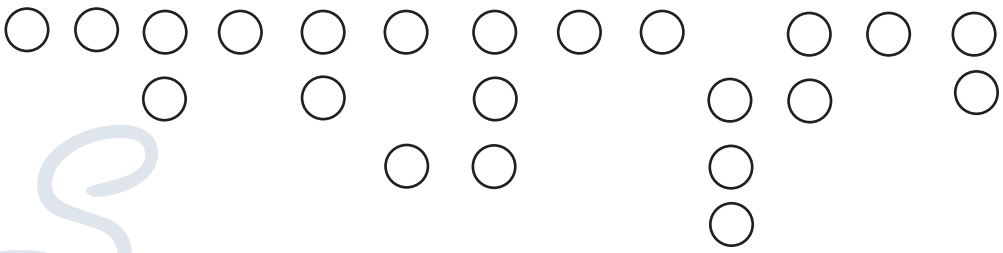

Spa Care and Maintenance

General Information

Your Saratoga Spa is manufactured from the highest quality, most durable materials available today. We recommend that a spa maintenance program be followed. The care you take will ultimately determine how long your spa or its individual components will last. This section will help you maintain your investment.

Replacing The Water

Proper spa maintenance (regular draining and replacing of spa water according to these directions along with filter cleaning), proper spa water treatment (water balance and maintaining correct sanitizer levels), and proper installation (adequate ventilation) are the keys to ensuring sanitary, healthy spa water.

It is recommended that you completely drain your spa every 45 to 90 days. Normally, after a period of time the water will become sudsy and harder to maintain and should be replaced. The NSPI WRI, Water Replacement Interval Formula is as follows:

$$\text{WRI} = \frac{.33 \times \text{Spa Volume in US Gallons}}{\text{Average Bathers per Day}}$$

Note: Heavy usage may require more frequent draining.

To Drain Your Spa:

1. Disconnect the spa from the power supply by tripping the GFCI breaker located in the house breaker panel or at the GFCI disconnect breaker at the spa.
2. Take off the equipment access panel by first removing the screws and then pulling out the access panel. Locate main drain valve and attach the inlet of a garden hose to the drain valve. Route garden hose to an appropriate draining area away from the spa to avoid flooding of the surroundings around the spa.

Note: Spa water with a high sanitizer level may harm plants and grass.

3. Open the drain valve by turning the knob. The spa will drain by gravitational flow.
4. Saratoga Spas will drain to the lower suction fittings in the footwell of the spa. It may be necessary to vacuum or sponge up a small amount of the remaining water in the spa.
5. When empty inspect the spa shell and clean as required.
6. Close the drain valve and remove garden hose.
7. Replace or close the equipment access door and replace screws.
8. Refill the spa through the filter compartment BEFORE restoring power.

Important:

Always clean the filter cartridges each time the spa is drained for cleaning.

Filter System

Saratoga Spas are equipped with two standard filter cartridges, except on the Empire and Broadway, which have two long filters and the Lincoln which has three standard filters. As with any filtering system, the filter cartridges may become clogged with particles, body oils or calcification resulting in poor water quality and reduced water flow. It is important to maintain a clean, unobstructed filtering system. A reduced water flow may cause a false High Limit reading or cause the circulation pump to burn out or turn off. If the circulation of water stops during sub-freezing temperatures and goes unnoticed, the spa water may freeze, which is not covered under manufacturers warranties.

WARNING:

The frequency and duration of use, and the number of occupants, all contribute to determining the appropriate time between filter cleanings. More use means that more frequent filter cleanings are required. Failure to maintain the cartridges in a clean, unobstructed manner will result in reduced water flow. Any damage to the spa (due to freezing) caused as a result of poor maintenance will not be covered by your spa warranty.

Filter Cartridge Removal and Cleaning

1. Disconnect the spa from the power supply by tripping the GFCI breaker at the spa.
2. Remove and carefully set aside the filter compartment cover.
3. Remove any floating items from within the filter compartment.
4. Grasp the handle of the filter cartridge and turn the cartridge clockwise until it is free from the base retainer. Leave screen adapter in place.
5. Place the cartridge on a clean surface and spray with a garden hose. It will be necessary to rotate the cartridge(s) to ensure all the filter pleats have been cleaned.
6. Continue cleaning by spraying down throughout the center of the cartridge (inside out).
7. For a complete and more thorough cleaning it is recommended to soak cartridges in a filter cleaning solution. Follow directions on the filter cleaner label.
8. Before inserting cartridges, do a final inspection of the cartridges.
9. To reinstall the filter cartridges, reverse the order in which the cartridges were removed.

WARNING:

Do not turn power on or use the spa with the filter cartridges or screen adapters removed!

Note: Spa cartridges are a disposable item and should be replaced each year.

Care of the Spa Pillows

The spa pillows used on Saratoga Spa models will provide years of comfort if treated with care. To extend their life the spa pillows should be removed and cleaned. Wash with a mild soap and water solution. ALWAYS rinse off the spa pillows thoroughly to remove any soap residue. If the spa is not going to be used for a long period of time the spa pillows should be removed until the next spa use.

To remove and replace the spa pillows:

1. Carefully lift one end of the pillow away from the spa shell.
2. Continue lifting one end until the pins on the bottom of the pillow are released from the pin retainer on the spa shell. Do the same to loosen the other end of pillow.

3. To reinstall the spa pillow, carefully bend the pillow slightly to allow the pins to slip into the pin retainer on the spa shell.
4. Keeping the pillow slightly bent, slide the other pins (opposite end) onto the pin retainer on the spa shell.
5. After all the pillow pins are in place, press the pillow down into the recess in the spa shell.

Important:

Just pulling the pillow straight up, and out of the shell recess, will eventually damage the pillow. This abuse is not covered under warranty.

Care of the Exterior

Spa Shell

Your Saratoga Spa is manufactured with a tough acrylic surface. Some staining or water marking may occur at or above the water surface. Removal of these surface conditions can usually be accomplished with a soft cloth by merely wiping them away. Stubborn stains can be removed first by draining the spa and then using a nonabrasive product. Always thoroughly rinse off any spa shell cleaning agent with fresh water.

Important:

Keep all cleaners out of the reach of children and use care when applying.

Spa Cabinet

The skirt around your Saratoga Spa is manufactured with the finest quality material and is available in a low maintenance exterior.

WeatherAll™ Skirt

The WeatherAll™ skirt combines the durability of plastic with the look of professionally finished wood. To remove any stains or dirt simply spray the skirt with water and wipe down with a soft cloth. WeatherAll™ is not designed to be stained or resealed.

Note: WeatherAll™ could experience natural fading due to sunlight and weather exposure.

Care of the Spa Cover

Vinyl Cover

Your vinyl thermal spa cover has been designed for your particular spa. Monthly cleaning and conditioning is recommended to maintain its beauty.

To clean and condition the vinyl cover:

1. Remove the cover from the spa and gently lean it against a wall or fence.
2. With a garden hose, spray the cover to loosen and rinse away dirt or debris.
3. Using a large, non-abrasive sponge and using a very mild soap solution (one teaspoon dishwashing liquid with two gallons of water) scrub the vinyl top in a circular motion. Make sure to rinse all soap off the cover before it dries.
4. Scrub the cover's perimeter and side flaps. Rinse clean with water.
5. Rinse off the underside of the cover with water only (use no soap), and wipe it clean with a dry rag.
6. To condition the cover after cleaning, apply a thin film of saddle soap (follow directions on the container) or vinyl conditioning cream.

Important reminders:

- **DO** unlock and release all cover locks before attempting to open cover.
- **DO** remove snow buildup to avoid damage of the foam core from the additional weight of the snow (not covered under warranty).
- **DO** lock cover lock straps to secure the cover when the spa is not in use.
- **DO NOT** drag or lift the spa cover using either the flaps, or the cover tie downs.
- **DO NOT** walk, stand, or sit on the cover.

Important:

Whenever the spa is not in use it is essential that the thermal cover be kept in place. When filled this ensures effective temperature maintenance and economical operation. When empty this prevents potential damage to the spas surface finish which can result from excessive heat caused by the sun. This type of damage is specifically excluded from warranty protection. It is recommended that the thermal cover tie downs always be used to discourage access to the spa by unsupervised children and minimize heat loss.

*The spa cover manufacturer handles all warranty claims. Saratoga Spa does not handle any warranty issues on the spa cover. Every Saratoga Spa is equipped with a locking cover that meets the ASTM F1346-91 standard for safety covers.

Winterizing Your Spa

If you chose not to use your Saratoga Spa during the winter is it recommended to properly winterize your spa. Any damage occurring due to accidental freezing of the spa is not covered under warranty.

The following steps are designed to protect your spa from freezing if followed. For ultimate protection against freeze damage to your spa, contact your local Saratoga Dealer to schedule a winterizing service plan.

1. Turn power off to the spa. Trip GFCI breaker.
2. Unscrew panel screws. Remove access panel.
3. Locate the drain valve and attach a garden hose to the drain valve.
4. Open the drain valve and allow the water to drain (Saratoga Spas will drain to the drain fitting in the footwell of the spa).
5. Remove filter cartridges and screen adaptors. Clean and store in a dry place.
6. Using a wet/dry shop vac vacuum, soak up the water remaining on the bottom of the spa.
7. Open unions at the heater and at the pump(s). Remove pump(s) from spa. Vacuum up water from return and suction sides of the plumbing on the pump(s). Vacuum any water from heater housing. Leave unions at the heater and at the pump(s) open.
8. Reverse vacuum and blow out each line of the plumbing going into the pump(s).
9. Remove drain plug(s) from pump(s). Vacuum up any water. Leave drain plug(s) open.
10. Place three cups of antifreeze in wet end of pump(s). Reinstall pump(s) with unions loose and drain plug(s) out.

Important:

Do not use ethylene glycol based antifreeze. This type of antifreeze is toxic and can damage the spa surface.

11. Place the vacuum hose down the filter cartridge openings and vacuum up any water from filter compartment.
12. Disconnect the unions at the circulation pump from both the return and suction side of pump.
13. Remove circulation pump.
14. Vacuum up both suction and return side of the circulation pump.
15. Reverse vacuum and blow out each side of circulation pump. Also, blow out and vacuum any water from the hoses coming into the circulation pump.
16. Reattach circulation pump and leave hoses unattached.
17. With a shop vac, go to every jet in the spa (including suction fittings) and place vac hose over the face of every jet and vacuum out any water left in the lines. Do the same to the filter housing and filter cartridge openings. Continue to do the same to the heater and the plumbing going into the pump(s). Remove every jet valve assembly and continue to vacuum out any water in the plumbing lines.
18. Wipe down spa shell with a soft clean cloth.
19. Place spa cover over spa and lock into place.
20. To restart the spa, connect all hoses and close all unions. Once all the hoses, jet valve assemblies, and pump unions are reattached, follow the normal fill-up procedures. It may be necessary to flush the spa depending on the amount of antifreeze used.

Note: It may be necessary to lubricate o-rings and gaskets for a positive seal. Use only Saratoga Spa approved lubricants, contact your local dealer for more information.

WARNING:

If these instructions are not followed, damage due to freezing water in the plumbing lines may occur and is not covered under manufacturers warranty.

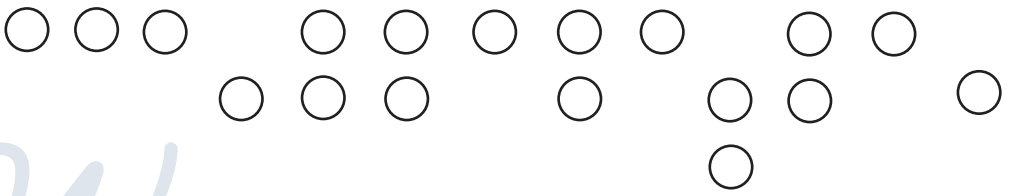

Water Quality Maintenance

General Information

As the owner of a spa, endless hours of entertainment, recreation, and relaxation await you. Caring for your spa will become a routine and pleasant part of your daily activities. You will be able to maintain your spa water and keep your spa equipment in excellent condition. To do so you first must balance your spa's water.

Balanced Water

Balanced water ensures spa bathers' safety as well as protecting the spa heater and components from corrosion. Also, balanced water protects the spa surface from unsightly scale deposits which reduce the efficiency of the spa equipment. You can obtain balanced water by correctly adjusting a few chemical components in the water. Specifically, you will need to adjust the pH, total alkalinity and calcium hardness

Note: Improper water chemistry can result in product failure and invalidate your warranty.

pH

pH is measured on a scale that runs from 0-14. pH indicates whether water is neutral, acidic, or basic. The drawing below shows a pH equal to 7.0 is neutral. A pH below this point is acidic and a pH above this point is basic.

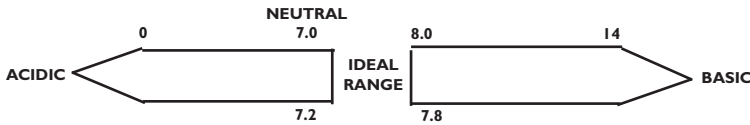

Recommended Range - 7.2 to 7.8

If the pH is too low it can

1. Corrode metal surfaces.
2. Use excess sanitizer.
3. Irritate bathers' skin and eyes.

If the pH is too high it can

1. Deposit scale on surfaces.
2. Contribute to cloudy water.
3. Cause eye irritation.
4. Reduce sanitizer efficiency.

Test pH weekly

Adjusting pH

To raise pH add a granular pH Increaser or sodium carbonate at the rate suggested on the container. To lower pH add a granular pH Decreaser, or sodium bi-sulfate at the rate suggested on the container. After initial application, allow water to circulate approximately 15 minutes on Pump 1 at high speed. Test pH and add second dose if required.

Total Alkalinity

There are minerals in your spa's water that act as buffering agents. Total alkalinity is the measurement of these alkaline materials that help prevent corrosion and staining. The correct amount of alkalinity in your spa's water will keep the water's pH consistent while allowing for economical pH adjustment when necessary.

Example: At low total alkalinity levels, the water's pH easily drifts, making frequent pH adjustments necessary and the added expense of multiple chemical treatments.

On the other hand, a high total alkalinity level keeps the water's pH rigidly fixed. If pH adjustment is necessary, you will need unusually large amounts of treatment chemicals to change the water's pH.

RECOMMENDED RANGE - 80 to 120 PARTS PER MILLION (PPM)

Potential Problems:

1. pH difficult to maintain. If total alkalinity is too low, pH will drift.
2. Corrosive tendencies. If total alkalinity is too high:
 - pH difficult to adjust (it remains fixed.)
 - Cloudy water.
 - Potential for scaling.
 - High pH and low sanitizer efficiency.

Testing Weekly

Adjusting Total Alkalinity

Total Alkalinity can be raised with Alkalinity Increaser, or sodium bi-carbonate at the manufacturer's recommendation for dosage.

Calcium Hardness

Calcium hardness is the amount of dissolved calcium in your spa's water. Too little calcium in the water will etch plaster surfaces, too much will leave deposits on surfaces and equipment.

Recommended Range: 125-150

Potential Problems:

Calcium Hardness Too Low:

- Some surfaces may be etched.
- May lead to equipment corrosion.

Calcium Hardness Too High:

- May contribute to cloudy water.

Adjusting Calcium Hardness

Raise hardness by the addition of calcium chloride. Decrease calcium hardness by draining spa and replacing with water containing lower levels of calcium hardness.

Disinfectant

- Brominating Tablets, Granular Bromine and Granular Chlorine are popular disinfectants and are particularly well suited to compliment your ozone purification system spa. They are also very suitable products in water with elevated temperatures.
- Brominating Tablets and Granular Bromine are effective as a spa water sanitizer and disinfectant. Follow manufacturer's directions for proper dosage. It is recommended to *maintain* an active bromine residual of 2.0 to 4.0 ppm.
- Granular Chlorine (Dichlor Dihydrate, Lithium Hypochlorite), is designed to dissolve quickly and completely, provide a steady source of available chlorine to control the growth of algae, kill bacteria and destroy organic contaminants. It is recommended to *maintain* a chlorine residual of between 1.0 and 3.0 ppm.. Non-Chlorine type shock will oxidize or destroy most of the organic contaminants that result from bather load. This quick acting oxidizing shock treatment goes to work almost immediately improving water quality and eliminating irritating wastes and odor. This product is intended to be a shock treatment only, and is not a disinfectant.

Shock Treatment with Granular Disinfectant

Adding granular chlorine or bromine disinfectant to the water in amounts much larger than normal is called “shocking” the spa and should not be confused with non-chlorine shock. An occasional shock treatment destroys algae, bacteria, and chloramines. After shocking your spa, do not allow bathers to enter the spa until disinfectant levels drop to normal.

What Causes Loss of Disinfectant?

- **Algae:** The presence of algae will consume large amounts of disinfectant. If you have an algae problem, the use of an algaecide in addition to disinfectant may be necessary.
- **Bather Load:** The greater the number of people using your spa, the more disinfectant you will need to use.
- **Improper pH:** A high pH above 7.8 substantially retards disinfecting. Keep the pH between 7.2 and 7.8.
- **Sunlight:** The sun’s Ultraviolet (UV) rays readily dissipate disinfectant levels.
- **Water Temperature:** High water temperature accelerates the loss of disinfectant.
- **Weather:** Rain and wind can carry a significant amount of contaminants into your spa.

Remember to Maintain:

- **pH 7.2 to 7.8**
- **Total alkalinity 80 to 120 ppm**
- **If using brominating tablets the proper level in dispenser**
- **Maintain granular chlorine residual level at 1.0 to 3.0 ppm**
- **Maintain bromine residual level at 2.0 to 4.0**
- **Calcium hardness 125-150**
- **Non-chlorine shock weekly or as needed based on spa use**

- **Test pH, total alkalinity and calcium hardness weekly**
- **Test disinfectant daily**

(Spa test kits are available through your Saratoga Spa Dealer.)

Ozone Generators

The Saratoga Spa Luxury Line comes equipped with an ozone generator. It automatically produces ozone 24 hours a day through our Whisper Clean® System, unless it is overridden by another system protection mode. (For ozone trouble shooting see page 56) The Ozone generator is equipped with a chip that will need to be replaced approximately every two years. This is a non-warranty item.

What is Ozone?

Ozone is nature’s natural purifier. It is a chemical known as O₃ and is produced from simple oxygen molecules in our atmosphere. Ozone will breakdown and oxidize oils, greases, suntan lotions, sweat, urea, etc. from spa water more effectively than any other oxidizer commercially available. Ozone also assists chlorine, or bromine, to destroy bacteria and viruses and will do so more effectively. Ozone only leaves simple oxygen in the water as a by-product.

How is Ozone Produced?

Ozone is produced in nature from lightning during electrical storms and is also produced from ultraviolet rays from the sun to form our protective ozone layer. Your ozone converter unit is designed to duplicate this natural sanitizer.

Note: Always follow instructions and dosages listed by chemical manufacturers. Use only

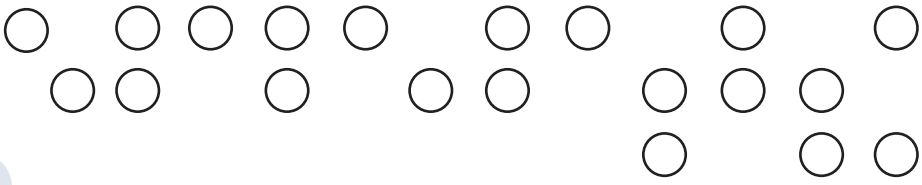

Operations Trouble Shooting Guide

Problem	Probable Cause	Solutions
Spa is not operating	<ul style="list-style-type: none"> • Power failure • GFCI breaker tripped • Heater Hi-Limit tripped 	<ul style="list-style-type: none"> • Check power source • Try resetting GFCI breaker. If breaker continues to trip, contact your dealer. • Check for dirty filters. Check to see if circulation pump is air locked.
Spa is not heating	<ul style="list-style-type: none"> • Dirty filters • Temperature setting too low • Pressure switch out of calibration • Air trapped in circulation line 	<ul style="list-style-type: none"> • Clean the filters • Increase the set temperature • Contact your dealer • Using a garden hose, force water through Whisper Clean® cartridge opening or loosen the bottom heater union to allow trapped air to escape.
Poor or no water flowing through the jets	<ul style="list-style-type: none"> • Dirty filters • Inadequate water level • Air lock 	<ul style="list-style-type: none"> • Clean the filters • Fill spa to 2" above filters • Prime the pump(s) by loosening unions on the pump(s) until air can be heard escaping, then tighten unions.
Spa light out	<ul style="list-style-type: none"> • Burned out bulb • Light not turned on 	<ul style="list-style-type: none"> • Replace bulb • Press the light key to desired intensity
Pump(s) turn off unexpectedly	<ul style="list-style-type: none"> • Automatic 15 minute shut off • Pump(s) may have overheated. Built in protective overheat shut off 	<ul style="list-style-type: none"> • Press jets button again to start another 15 minute cycle • Let pump sit for about 10-15 minutes. Allow pump to cool down, keep vented areas on access panel free from blockage.

Operations Trouble Shooting Guide Cont...

Problem	Probable Cause	Solutions
Spa jets/pump(s) turn on automatically	<ul style="list-style-type: none"> • Normal power filtration cycle • Summer Setting mode cycle activated • Smart Winter mode cycle activated 	<ul style="list-style-type: none"> • No action necessary • No action necessary • No action necessary
Not able to operate main control panel	<ul style="list-style-type: none"> • Panel may be locked • Panel may have malfunctioned 	<ul style="list-style-type: none"> • Hold down blower key until “Uloc” appears on the digital display • Contact your dealer
Water does not clear up	<ul style="list-style-type: none"> • Bad water chemistry • Dirty filter cartridges • Ozone generator not operating or ozone chip needs replacement through window on ozone generator • Bromine/chlorine residual levels too low 	<ul style="list-style-type: none"> • Balance water • Clean or replace filters • Locate ozone generator; look for ultraviolet light to be illuminated • Adjust Bromine/chlorine levels. Shock if necessary. May have to replace water

Diagnostic Display Messages on Main Control Panel

Smart Winter Mode / Flashing ▲ above filter icon

This system prevents the water from freezing in the plumbing or the pumps. An onboard sensor continuously checks the ambient air temperature in the control pack. If at any time the temperature falls from a range of 43°F the Smart Winter Mode will be activated for the next 24 hours, even if the temperature returns to above 43°F. During this Smart Winter Mode the range of temperature will determine the frequency of the pumps operation. The colder the ambient temperature, the more frequently the pumps will run. The time range will vary from every 15 minutes to every 2 hours. When the pumps are operating because of this feature, the filter cycle icon on the display will flash. No corrective action is necessary.

Summer Setting Mode / “SSEt”

Your spa is equipped with this feature to prevent heat build up. The “SSEt” does not apply to the Polo, Adelpi and Putnam. A “▲” will flash below the filter icon on these models’ control panel.

Standard (Outdoor) Mode: When water temperature is 2°F greater than set temperature, the circulation pump and ozone generator will turn off for 3 hours. After 3 hours the circulation pump and ozone generator will turn on again for 1 hour and pump 1 will run for 1 hour then turn off again for 3 hours; this cycle will keep repeating. When the circulation pump and ozone generator are off “SSEt” and the water temperature are alternately displayed on the panel (SSEt = summer setting). The circulation pump turns on automatically if the water temperature drops below 1°F of the set temperature.

Indoor Mode: When the water temperature is 2°F greater than set temperature the circulation pump and ozone generator will turn off for 3 hours. After 3 hours the circulation pump and ozone generator will turn on again for 1 hour but pump 1 will not operate in the indoor mode. This cycle will keep repeating. When the circulation pump and ozone generator are off, “SSEt” and the water temperature are alternately displayed on the panel (SSEt=summer setting). The circulation pump turns on automatically if the water temperature drops below 1°F of the set temperature. Indoor mode is activated by moving Jumper #8 to the right position. Check with your Saratoga dealer for further information. The Indoor Mode does not apply to the Polo, Adelphi, or Putnam models.

“...” (3 dots flashing):

- The filter(s) may be plugged. Remove filter(s) and clean.
- The amount of water flow may be inadequate. Make sure the water level is correct.
- A pressure switch may have malfunctioned.

Note: If the open pressure switch error persists for more than 5 minutes, the circulation pump output will enter an open pressure switch error cycle which consists of stopping the circulation pump for 10 seconds, then start the circulation pump for 5 minutes. The cycle will repeat three times prior to a final power down of the circulation pump. If any manual key is pressed the system will restart three cycles.

“122°F” or “32°F”:

Open sensor (spa is deactivated): The main temperature sensor is nonfunctional. This must be repaired only by a Dealer or service organization.

“SSEt” Summer Setting:

The Summer Set mode has been activated. The water temperature is 2°F above the set temperature. The Summer Set Mode will shut off after the water temperature is 1°F below the set temperature. The “SSEt” does not apply to the Polo, Adelphi, or Putnam models. A “▲” will flash below the filter icon on these models’ control panel.

“HL” or “...” (3 Dots Flashing) with red light (located on PC board):

Overheat protection (spa is deactivated): If a malfunction occurs and the spa water reaches 112°F, the system will completely shut down. In such a condition, **DO NOT ENTER THE WATER.** Turn off all power to the spa and contact your Dealer or service organization.

Temperature Flashing:

Power to spa has been interrupted. Press any key on panel and temperature should stop flashing. Temperature may also flash when spa has overheated. In such a case, contact your Dealer and **DO NOT ENTER WATER.**

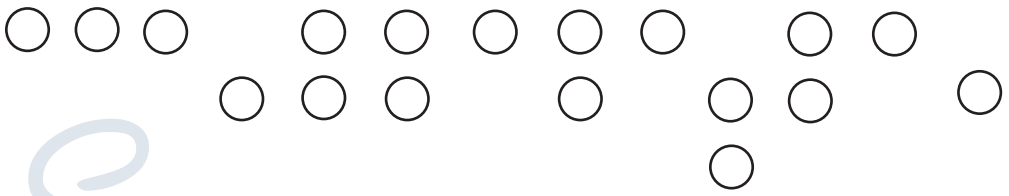

Service and Warranty Information

General Service Information

Your Saratoga spa has been designed to provide years of trouble-free use. As with any appliance, problems may occasionally occur that require the expertise of a qualified service person. Though such simple repairs as resetting a GFCI switch or breaker, resetting a high limit thermostat or replacing a light bulb may not require a service call, they may indicate that a more serious condition exists. These conditions may require an experienced service person. Before calling for service, please refer to the Troubleshooting Guide.

Note: Always retain your original sales receipt for future reference.

Acts Invalidating Warranty

The limited warranty is void if the Saratoga spa has been improperly installed, subjected to alteration, misuse, or abuse, or if any repairs on the spa are attempted by anyone other than an authorized representative of Saratoga Spa Company. Alteration shall include any component or plumbing change, electrical conversion, or the addition of any non-approved sanitation or water purification device, or heating system which contributes to component or unit failure or unsafe operating system. Misuse and abuse shall include any operation of the spa other than in accordance with Saratoga Spa Company printed instructions, or use of the spa in an application for which it is not designed; specifically: use of the spa in a non-residential application; damage caused by operation* of the spa at water temperatures outside the range of 35°F and 120 °F; damage caused by a dirty, clogged or calcified filter cartridge; damage to the spa components or spa surface determined to have been caused by improper water maintenance or improper use of chemicals (refer to pages 52-54 of this owners manual); damage caused by allowing undissolved spa sanitizing chemicals to lie on the spa surface (no spa surface material can withstand this kind of abuse); and damage to the spa surface caused by leaving the spa uncovered while empty of water and in direct exposure to sunlight (this may cause solar heating distress in warm weather regions). These are considered abuses and may invalidate this warranty.

Acts of nature, and damage caused by animals, rodents, and insects are considered abuses and are not covered under this warranty.

*Operation of the spa does not mean “use” of the spa! Saratoga Spa Company does not recommend using the spa if the water temperature is above or below the spa’s control panel temperature range.

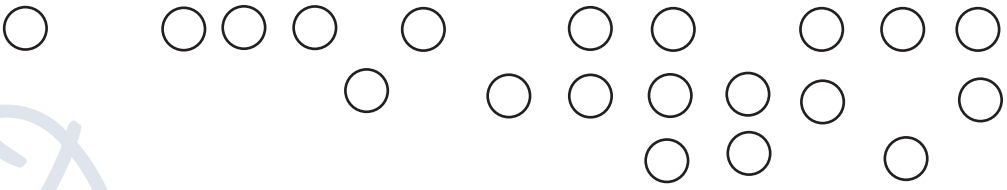

Disclaimers

Saratoga Spa Company shall not be liable for loss of use of the Saratoga spa or other incidental, consequential, special, indirect, or punitive costs, expenses or damages, which may include but are not limited to the removal of a permanent deck or other custom fixture or the necessity for crane removal. Any implied warranty shall have a duration equal to the duration of the applicable limited warranty stated above. Some states do not allow limitations on how long an implied warranty lasts. Under no circumstances shall Saratoga Spa Company or any of its representatives be held liable for injury to any person or damage to any property, however arising.

Some states do not allow the exclusion or limitation of incidental or consequential damages, so the above limitations may not apply to you.

Saratoga Spa Replacement Parts



Saratoga Luxury Line Microban® Filter
4 3/4" x 12 5/16"

74455



Saratoga Luxury Line Microban® Filter
4 3/4" x 16 1/2"
(Empire and Broadway)

74457



Screen adapters for base of filter cartridge
NPT Screen adapter
ACME Screen adapter

74450

74451



Standard #888 grey pillow

74330



Lincoln grey pillow

74331

Additional Accessories



Spa Cover Lifter
Lifts any spa cover up to 96" without hydraulics 149834
* Broadway Model * 149835

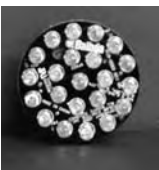

Retrofit 22 LED light
Displays various color shows

70400

Additional Accessories

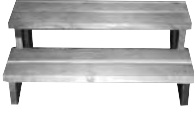

084007, 084006

2x3 Cedar spa step-ups offered in three different colors

Red Cedar	084007
Grey Stain	084006
Unstained	084004



Colored light lenses set for your spa light
(one blue lens and one red lens)

31795

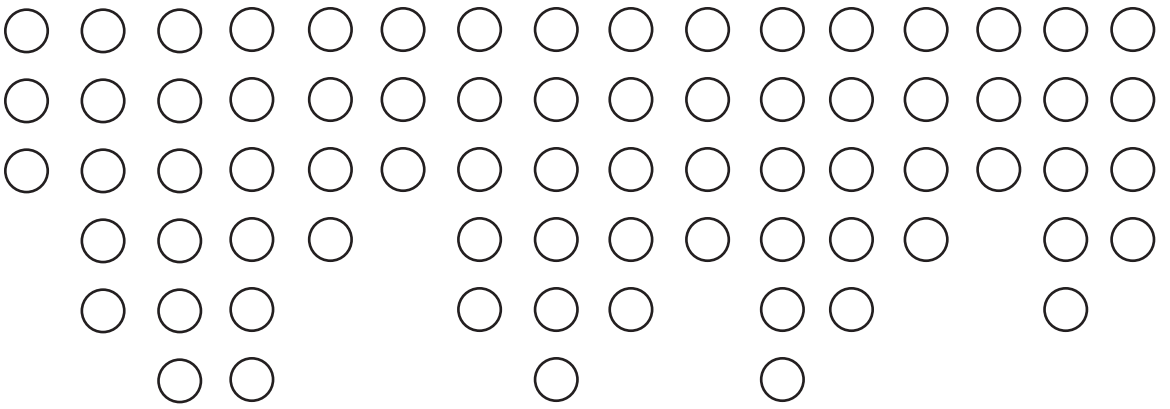

33 Wade Road
Latham, NY 12110
1-800-444-9977
fax: 518-782-0632
www.SaratogaSpa.com



#25013 04/05